



EIFS | STUCCO | FOAM
TOOLS AND EQUIPMENT



TABLE OF CONTENTS

Fasteners.....	4-9	Pry Tools and Scoops.....	40-41
Rasps.....	10-13	Tapes.....	42
Hot Knives/Tools.....	14-21	Water Management.....	43-44
Groove Tools/Inserts.....	22-23	Foam-Lok [™] Adhesives.....	45
Hot Rod/Magnums.....	24-25	Pro-Lok [™] / EnerFoam.....	46-47
ICF/SIPS & Bow Cutters.....	26-27	Cleaners.....	48
Table Top Cutters.....	28-29	Soft Foam Saws.....	49
Mixers.....	30	Specialty Coatings.....	50-51
Trowels.....	31-35	Craft & Hobby.....	52
Floats.....	36-37	Website Items.....	53-56
Stucco Tools & Blades.....	38-39	News.....	57



EIFS / STUCCO AND MASONRY TROWELS

IMPROVED DESIGN



REINFORCED CENTER HUB



ERGONOMIC DESIGN

Innovation made Demand Products—seeing and doing what others did not.

When we opened our doors in 1983, we offered fasteners, a small selection of hand tools and 10+ years of knowledge gained working in the field. Today we carry more than 1000 products. Our experience working side by side with architects and contractors kept us focused on quality throughout the entire process.

Quality tools are vital to the success of every project. They are the foundation of the building process. Only the best tools yield the best results. That's why we take the time to ensure every item offered by Demand Products is of the highest quality.

You rely on our experience and knowledge to guide you to the right products for your job. For this reason, we make sure everyone at Demand Products meets those same high quality standards. Just as our tools always outperform the competition, you'll find the same holds true with our team. Everyone goes the extra mile to deliver quality results.

Call today and let us help you find the high quality products you need for your next job.

HOW TO ORDER

Orders can be placed through your local distributor or directly with Demand Products. Call 800-325-7540 for assistance locating a distributor in your area. Our operating hours are from 8:00am to 5:00pm (EST), Monday through Friday. Orders can be placed online, emailed to sales@demandproducts.com or faxed to 888-534-8383, 24 hours a day. *All prices are in US dollars and are subject to change without notice.*

RETURN POLICY

Unless otherwise specified at the time of sale or on website orders, Demand Products Inc., will accept the return of merchandise for exchange or credit only with advance written authorization. Returned materials will be credited at the actual cost paid as determined by the proof of purchase, LESS ALL FREIGHT COSTS paid by Demand Products Inc. We do not accept returns on chemicals or coatings and some electronics. Returns must be made within 15 days of invoice and must be in new, re-stockable condition upon receipt. Materials returned must be shipped prepaid. Discontinued items and custom orders cannot be returned. Returns are subject to a minimum 15% restocking fee.

WARRANTY

Unless specified differently at the time of sale or on website orders, all of our products carry an unconditional 6-month guarantee. Demand Products must be notified in writing within 48 hours of receipt of defective or damaged merchandise or shortages. Any equipment or tools that are disassembled without prior written consent from Demand Products will have the warranty voided. Defective products may either be replaced or repaired at no charge. Abused tools may be repaired and returned only if the customer consents to charges. The maximum amount of Liability Demand Products Inc., shall have is the actual purchase price of products obtained through this catalog. No warranties of Merchantability of fitness for a particular purposed are conveyed through this printing. Proper Operation and Maintenance. Buyer must properly operate and maintain the product, including parts and accessories, in compliance with all operation and maintenance instructions, in normal use, and in good condition and repair. Authorization for modification. Buyer must obtain written authorization from Demand Products before making any modification of any product, part or accessory.

FREIGHT POLICY

In case any SHORTAGE OR DAMAGE incurred during transportation is detected, notify the delivering transportation agent and Demand Products Inc., immediately. If the Customer's freight carrier is used, the Customer must file a claim immediately with their freight carrier, within 5 calendar days from receipt of goods, or risk losing any recovery. Our responsibility for delivery of goods ends when we have our signed Bill of Lading by our local transportation agent. Upon Customer request, replacement shipment will be made subject to general terms and conditions as a new order.

TERMS OF SALE

General terms of sale applicable to most items and services sold, including any dispute resolution requirements, can be located on our website at: demandproducts.com/legal or by calling us at 800-352-7540 to request a copy.

PLEASE NOTE — DISCLAIMER

The products in this catalog are offered as options to the purchaser as-is or subject to conditions at the time of sale. The product descriptions and/or photos described or shown may have changed since publication of this catalogue. Any and all portions of this catalogue may not be reproduced in anyway withing prior written consent from Demand Products, Inc. The contents of this catalogue, including but not limited to the text, images and their arrangement are copyright 2021 by Demand Products, Inc. All Rights Reserved. All 3rd Party vendors logos are the property of each respective vendor. PRICES ARE SUBJECT TO CHANGE WITHOUT NOTICE. PRODUCTS ARE SUBJECT TO BE DISCONTINUED FOR SALE WITHOUT NOTICE.

IMPROVED DURABILITY Redesigned for Ideal Weight Distribution—Adding More Strength and Flexibility

THE ORIGINAL **INDUSTRY LEADER** SINCE 2000

PBH™ WASHER

The Builder's Choice

- 2" Diameter
- Manufacturer Approved
- Cone Design Prevents Popups
- White - Seamless Color
- Added Strength & Flexibility
- Finger Closures
- Eliminates Thermal Shorts
- Large Keyholes for Strong Mechanical Bond

Available in Boxes of 500 and 1000



Item #	Description	Qty Per Box
PBH	PBH Washer	1000
PBH500	PBH Washer	500

Fastener Patterns & Wind Load Specs on Page 7

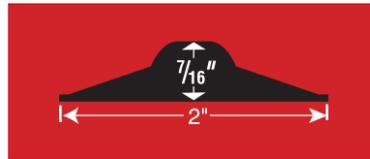

Reinforced Center Hub

- Helps Reduce Overdriving



POLYMER MODIFIED WASHERS



DP300 WASHER

All Purpose PM Washer

- Low Profile Design Seats Flush
- Key Holes Create Strong Mechanical Bond
- Large 1 3/4" Diameter
- Strong Polypropylene Material Provides Impact Resistance and Long Life
- Use for Lath and Plastic Lath Attachment

Item #	Qty Per Box	Box Weight
DP300	1000	6 Lbs



DP300 WASHER

Pre-Assembled with Wood Screw

Item #	Size	Insulation Thickness	Qty Per Box	Box Weight
D3W1	1 5/8"	1"	1000	Approx. 14 Lbs
D3W2	2"	1 1/2"	1000	Approx. 16 Lbs
D3W3	2 1/2"	2"	1000	Approx. 18 Lbs

DP300 AND DP400 Washers Secure Rigid Insulation to Multiple Substrates

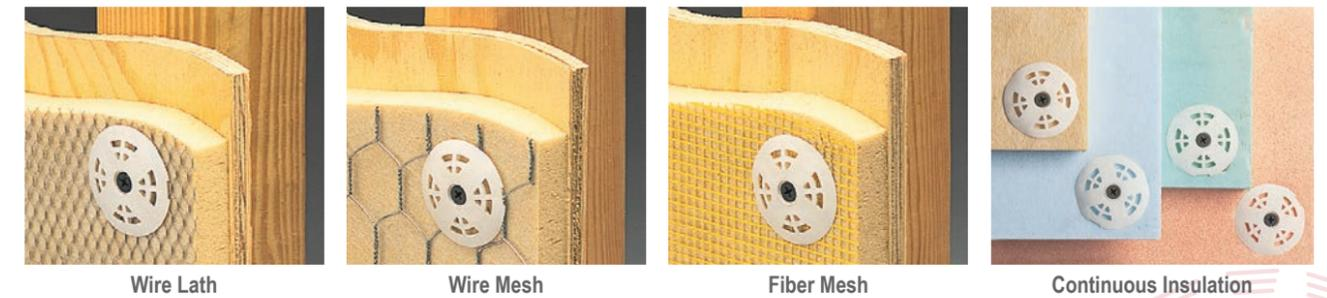

WOOD / LITE-METAL

20 to 26 GAUGE

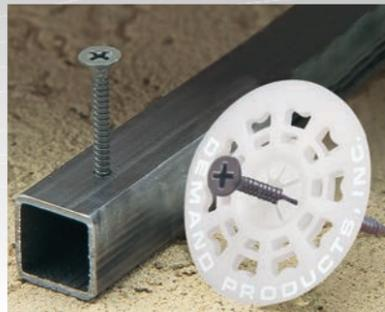

STEEL 12 to 20 GAUGE



MASONRY - SOLID OR BRICK

PBH with Wood/Lite Metal Screw

PBH and Wood/Lite-Metal Screws, Assembled with Washer for Wood and Lite-Gauge Metal Application, 20- to 26-gauge

Item #	Size	Insulation Thickness	Qty Per Box	Box Weight
WH1	1 5/8"	1"	1,000	16 lbs
WH2	2"	1 1/2"	1,000	18 lbs
WH3	2 1/2"	2"	1,000	20 lbs
WH4	3"	2 1/2"	1,000	22 lbs
WH6	4"	3 - 3 1/2"	1,000	39 lbs
WH7	5"	4 - 4 1/2"	1,000	47 lbs
WH8	6"	5 - 5 1/2"	1,000	56 lbs

PBH Washer with Steel Screw

PBH and Steel Screws, Assembled with Washer for Heavy-Gauge Metal Application, 12- to 20-gauge

Item #	Size	Insulation Thickness	Qty Per Box	Box Weight
SH1	1 5/8"	1"	1,000	17 lbs
SH2	1 7/8"	1 1/2"	1,000	19 lbs
SH3	2 5/8"	2"	1,000	21 lbs
SH4	3"	2 1/2"	1,000	24 lbs
SH5	4"	3" - 3 1/2"	1,000	36 lbs
SH6	5"	4" - 4 1/2"	1,000	48 lbs

PBH with Tapcon™ Screw

PBH and Masonry Screws, Assembled with Washer for Concrete and Masonry Application

Item #	Size	Insulation Thickness	Qty Per Box	Box Weight
MH1	1 3/4"	1"	1,000	20 lbs
MH2	2 1/4"	1 1/2"	1,000	24 lbs
MH3	2 3/4"	2"	1,000	26 lbs
MH4	3 1/4"	2 1/2"	1,000	28 lbs
MH5	4"	3"	1,000	32 lbs
MH6*	5"	4"	1,000	38 lbs



DP400 WASHER

Time Saving Pre-Spot Stem

- Low Profile Design Seats Flush
- Key Holes Create Strong Mechanical Bond
- Large 1 3/4" Diameter
- Strong Polypropylene Material Provides Impact Resistance and Long Life

Item #	Qty Per Box	Box Weight
DP400	1000	6 Lbs

Fastener Patterns & Wind Load Specs on Pages 7



DP500 TAB WASHER
Great for Lath & Stucco

- Meets ASTM A653 Standard
- 1 1/4" Diameter Plate
- Can be Screwed, Nailed or Shot
- Covers Many Rigid Insulation Applications

Item #	Qty Per Box	Box Weight
DP500	1000	6 Lbs

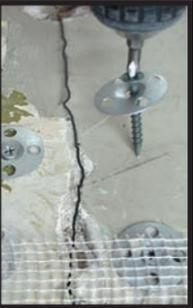

DP525 WASHER
Plaster Repair Washers

- 24 Gauge Grip-Guard™ Galvalume Coated Steel
- Helps Stabilize and Re-Support Old Plaster
- 1 1/4" Diameter Plate
- Tapered Edge Will Not Catch Trowel Edge

Item #	Qty Per Box	Box Weight
DP525	1000	6 Lbs
DP525-1	100	1 Lb

Wind Load Capacity

(Average Ultimate PSF, Negative Pressure)

1 Lb EPS	Pattern A	Pattern B
1"	83	85
1 1/2"	105	104

These spacing patterns are general guidelines for mechanical installation of EPS to different substrates when used in conjunction with a typical EIFS system or similar systems. Construction projects vary and yours may be different from these fastener suggestions. Please consult your EIFS manufacturer when using Demand fasteners along with adhesives. For additional information call Demand Products Technical Services at 1-800-325-7540.

A

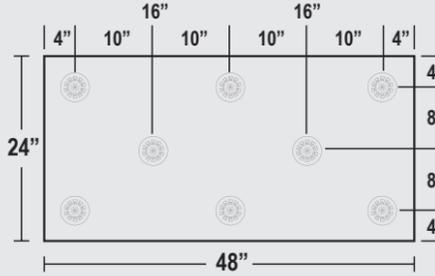

Wood, Plywood, Metal Siding & Masonry

B

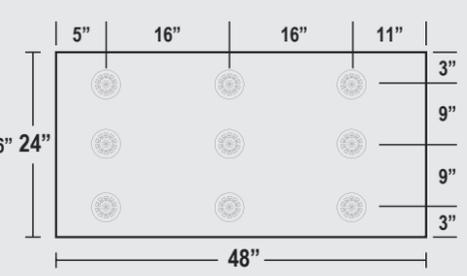

Structural Substrates such as Wood Sheathing, Concrete, Masonry & Metal Siding

C

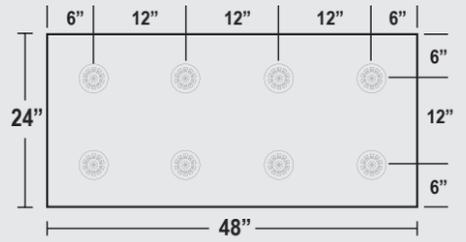

Wood, Plywood, Metal Siding, Masonry

Represents suggested fastening patterns and installation tips to ensure proper attachment.

CONTINUOUS INSULATION

CI Mandate Effects
90% of New US Building Sites



CODE REQUIREMENT

- R-13 CAVITY BATT + R3.8 CI or + R7.4 CI
- R-13 CAVITY BATT WITH NO CI

US Department of Energy Mandate
US Department of Energy (DOE) mandated all affected states must update their commercial building code to meet or exceed American Society of Heating, Refrigeration, and Air Conditioning Engineers (ASHRAE) standard 90.1-2010

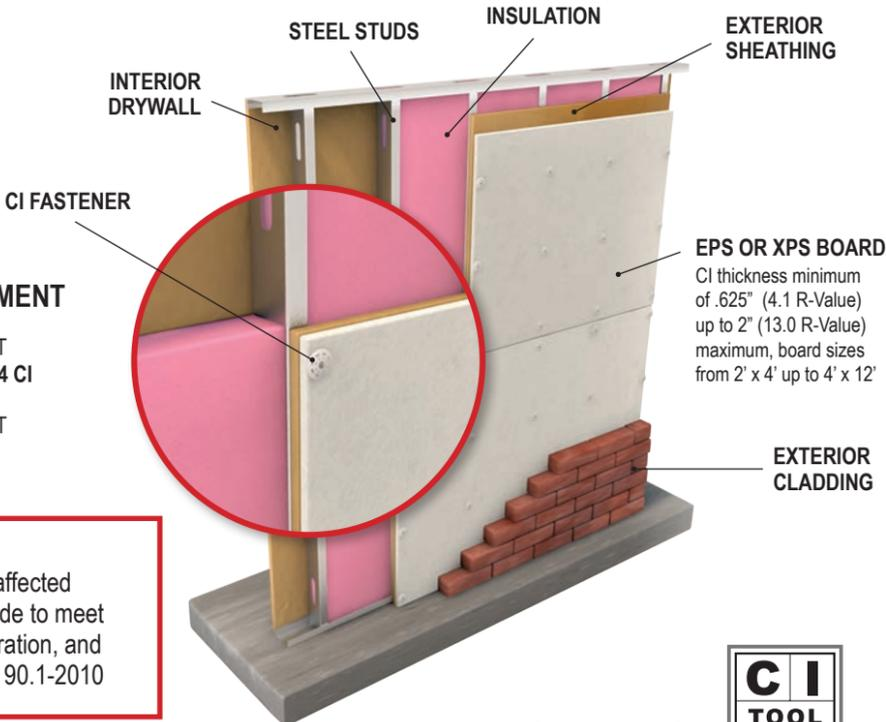

Look for this logo for Specialized CI Tools



WIND LOAD SPECS



PBH Washers

Fastener Pull-Through Results in Average Pounds Ultimate

Tapcon	Dec-King	S-12
401	410	427

Insulation Pull-Over Results in Aver. Pounds Ultimate (1 Lb Density EPS)

1"	1 1/2"	2"
85.6	93.6	108

The 2" diameter of PBH Washers increases wind load resistance and has 25% more pullover value than 1 3/4" washers. Structural performance tests conducted with ASTM E-330. Average ultimate negative load was -97 PSF.

Testing was performed by Underwriters Laboratories per ASTM E330 and E331. Procedure B.

DP300 Washers

Diameter: 1 3/4"
Material: Polypropylene
Push Through @ 10° 256 lbs.
Push Through @ 180° 177 lbs.
Pull Over 50.8 lbs. @ 10°
Pull Over 122.4 lbs. @ 180°



DP400 Washers

Diameter: 1 3/4"
Material: Polypropylene
Push Through @ 10° 256 lbs.
Push Through @ 180° 177 lbs.
Pull Over 50.8 lbs. @ 10°
Pull Over 122.4 lbs. @ 180°



DEPTH STOP 2.0
Sets Washers Consistently

- Works with Screw Guns and Drills
- Consistent Seating Depth
- Interchangeable Bit
- Fully Adjustable
- Prevents Overdrive



DSTOP

WOOD - LITE METAL



WOOD-LITE METAL DEGRASHIELD™ COATED
For Use with Wood & Metal from 26 to 20 Gauge

Item #	Description	Qty Per Box
WS1	7 X 1 5/8"	1,000
WS2	8 X 2"	1,000
WS3	8 X 2 1/2"	1,000
WS4	8 X 3"	1,000
WS6	8 X 4"	1,000
* WS7	10 X 5"	1,000
* WS8	10 X 6"	1,000

* Coarse Thread

PREMIUM COATED SCREWS



STEEL CLIMASEAL™ PROTECTION
For Use with Steel from 20 to 12 Gauge Studs

Item #	Description	Qty Per Box
SS1	6 X 1 5/8"	1,000
SS2	6 X 1 7/8"	1,000
SS3	8 X 2 3/4"	1,000
SS4	8 X 3"	1,000
SS5	10 X 4"	1,000
* SS6	10 X 5"	1,000
* SS7	10 X 6"	1,000

* Truss Head

MASONRY CLIMASEAL™ PROTECTION
For Use with Concrete Block, Poured Concrete or Masonry

Item #	Description	Qty Per Box
MS1	3/16 X 1 3/4"	1,000
MS2	3/16 X 2 1/4"	1,000
MS3	3/16 X 2 3/4"	1,000
MS4	3/16 X 3 1/4"	1,000
MS5	3/16 X 4"	1,000
* MS6	1/4 X 5"	1,000

* Drill Bit Not Included

10 FREE MDB55 Drill Bits per box of 1,000 screws.

LONG STEEL SCREWS

- Double Flute Drill Point Speeds Penetration Through Steel Deck
- Exclusive Tapered Entry Threads Wedges Fastener Tightly Into the Deck for Superior Back-Out Resistance
- Black e-Coat Coating Offers Excellent Corrosion Resistance
- FL and Miami-Dade Approved

* Will not work with PBH, DP300 and DP400

Item #	Description	Qty Per Box
SS7	12 X 6"	1000
SS8	12 X 7"	1000
SS9	12 X 8"	1000
SS10	12 X 9"	1000
SS11	12 X 10"	1000
SS13	12 X 12"	1000

LONG WOOD SCREWS
Course Wood Screws

- 3/8" Lag Screw Replacement
- No Pre-Drilling
- Flat Head Provides Great Finished Look
- Sharp Gimlet Point for Fast Installation Into Wood and OSB
- Aggressive Thread for Holding and Withdrawal Strength
- Free SpiderDrive™ Bit in Every Package

* Will not work with PBH, DP300 and DP400

Item #	Description	Qty Per Box
WS9	14 X 7"	250
WS10	14 X 8"	250
WS11	14 X 10"	250

EPS FOAM AUGER
Spiral Anchoring to EIFS

- For Downspouts, Lights, Fixtures, etc.
- High Strength Plastic Construction with Foam Washer
- 2 1/4" Deep x 1" Wide with 1/8" Washer
- No Thermal Bridging
- Can Be Installed with Drill



Item #	Qty Per Box	Box Weight
SD10	10	1 Lb

FOAM TACK FASTENER
Holds Foam to Foam

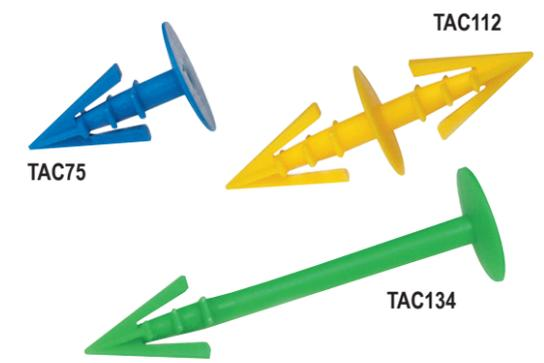

Item #	Description
TAC75	3/4" Trim to Foam Trim Tac (Pak of 250)
TAC112	1 1/2" Foam to Foam Insul Tac (Pak of 250)
TAC134	1 3/4" Foam to Foam Arrow Tac (Pak of 250)

SCREW PULLOUT PERFORMANCE DATA: WOOD AND LITE METAL

WOOD



Wood/Lumber Pullouts 1/4" Minimum Through Penetration					
Penetration Dimensional Lumber	1/2"	3/4"	1"	1 1/4"	1 1/2"
Pullout Strength	180	250	400	550	650

Conforms to ASTM C-548 & C-1002

LITE METAL



Light Gauge Metal Pullouts 1/4" Minimum Through Penetration				
Normal Gauge	20	22	24	25
Pullout Strength	300	244	190	178

Conforms to ASTM C-954 & C-548

SCREW PULLOUT PERFORMANCE DATA: STEEL, CONCRETE AND MASONRY

STEEL



Steel Screw Pullouts Source: Grabber				
Penetration Dimensional Lumber	14	16	18	20
Pullout Strength	642	483	346	174

*fasteners comply with ASTM C1002 and are approved for use by the Uniform Building Code

MASONRY



Depth of Embedment in Solid Material (Inches)	1"	1 1/4"	1 1/2"	1 3/4"
Normal Gauge	209*	357*	468*	547*

Test #CH3748/Pittsburgh Testing Laboratories

Coating: Climaseal™ for heavy metal
Corrosion Resistance: **Kestemich Results** (Din 50018, 2.OL) 15 cycles - no red rust.
Salt Spray Results: (ASTM B117) 1000 hours - no red rust.

Coating: Blue Climaseal™ for masonry/concrete fasteners only
Corrosion Resistance: **Kestemich Results** (Din 50018, 2.OL) 30 cycles - 10% or less red rust.
Salt Spray Results: (ASTM B117) 720 hours - 10% or less red rust.

*Note 1: Masonry must be pre-drilled 1/2" deeper than fastener penetration.
*Note 2: Hardness of masonry varies and the standard drill bit may not always drill the adequate hole. Consult Demand Products for assistance in proper drill bit diameter.
Please Note: The pullout values listed are the ultimate averages achieved under laboratory conditions. An appropriate safety margin factor should be applied to these values to achieve a design value.



ORIGINAL DURARASP™
12-Grit Tungsten Carbide Rasp

- Non-Gouging Rounded Corners
- Custom Crafted and Serial Numbered
- Lasts 100 Times Longer than Rasp Paper
- Ergonomic Handle

Item #	Description
DR214	2" x 14"
DR414	4" x 14"
DR614	6" x 14"
DR814	8" x 14"

Tiger Claw™

TIGER CLAW DURARASP™
For Rasping, Cutting & Shaving EPS Foam

All the Features of the DuraRasp™, Plus...



Cut-Off Saw



Shaves High Spots



Item #	Description
TC414	The Tiger Claw™ 4" x 14"
TC614	The Tiger Claw™ 6" x 14"
TC814	The Tiger Claw™ 8" x 14"



Ergonomic Handle with Finger-Flow
Ribs for Comfortable Control



Rounded Corners



SMOOTHIE™ DURARASP™
24-Grit Tungsten Carbide Rasp

- Ornamental Shapes & Base Coats
- Custom Crafted and Serial Numbered

Item #	Description
SM414	Smoothie™ 4" x 14"
SM614	Smoothie™ 6" x 14"



DURARASP™ EDGER
2 Sided Tungsten Carbide Rasp

- Heavy #12 Tungsten Grit
- Ergonomic Handle

Item #	Description
DE614	Edger Rasp™ 6" x 14"



BPVAC



Rasp Not Included

Vacuum Back Pack

- Commercial 2 HP Two Stage Motor
- Lightweight 9 3/4 lbs
- 7 Quart Tank Capacity
- 5' Locking Hose Plus Wands
- 50' Power Cord

Item #	Description
BPVAC	Shop•Vac Back Pack Vacuum
BPVACPO1	Replacement Bags - 5 Pack



KITDVH

Specifications
 Dimensions: 7"W x 15"L
 Rasp Surface: 6" x 14"
 Hose Size: 1 1/2"

DURAVAC™ RASP Vacuum Hand Rasp

- Lightweight: Weighs only 2 1/2 lbs
- Quickly Removes EPS Dust
- DuraRasp™ Plate Delivers Long Life
- Constructed with Lightweight Commercial Grade Aluminum
- Connects to Any Commercial Vacuum

Item #	Description
KITDVH	Hand Vacuum DuraRasp™
VRP614	Vacuum DuraRasp™ Replacement Plate, 6" x 14"



DR448PL

48" DURARASP™ Tungsten Carbide Rasp

- Custom Crafted
- Heavy Duty #12 Tungsten Grit
- Lasts 100 Times Longer Than Rasp Paper

Item #	Description
DR448PL	DuraRasp™ 48"
DR448S	Replacement Rasp Plate



AS614

RASPING TOOLS Standard Hand Rasp

- High Quality Aluminum Plates
- 16 Grit Adhesive Paper

Item #	Description
AS414	Aluminum Standard Rasp, 4" x 14"
AS614	Aluminum Standard Rasp, 6" x 14"
AS814	Aluminum Standard Rasp, 8" x 14"

RASP PAPER SHEETS Adhesive Rasp Paper

12-Grit Rasp Paper

Item #	Description
ARP41412	Rasp Paper, 4" x 14"
KITARP41412	Rasp Paper, 12 Pack, 4" x 14"
ARP61412	Rasp Paper, 6" x 14"
KITARP61412	Rasp Paper, 12 Pack, 6" x 14"
ARP81412	Rasp Paper, 8" x 14"
KITARP81412	Rasp Paper, 12 Pack, 8" x 14"
ARP81812	Rasp Paper, 8" x 18"
KITARP81812	Rasp Paper, 12 Pack, 8" x 18"

16-Grit Rasp Paper

Item #	Description
ARP414	Rasp Paper, 4" x 14"
KITARP414	Rasp Paper, 12 Pack, 4" x 14"
ARP614	Rasp Paper, 6" x 14"
KITARP614	Rasp Paper, 12 Pack, 6" x 14"
ARP814	Rasp Paper, 8" x 14"
KITARP814	Rasp Paper, 12 Pack, 8" x 14"
ARP818	Rasp Paper, 8" x 18"
KITARP818	Rasp Paper, 12 Pack, 8" x 18"

BULK RASP PAPER Non-Adhesive Rasp Paper

16-Grit Rasp Paper

Item #	Description
BRP250	Bulk Rasp Paper, 2" x 50 yds
BRP450	Bulk Rasp Paper, 4" x 50 yds
BRP650	Bulk Rasp Paper, 6" x 50 yds
BRP850	Bulk Rasp Paper, 8" x 50 yds

12-Grit Rasp Paper

Item #	Description
BRP25012	Bulk Rasp Paper, 2" x 50 yds
BRP45012	Bulk Rasp Paper, 4" x 50 yds
BRP65012	Bulk Rasp Paper, 6" x 50 yds
BRP85012	Bulk Rasp Paper, 8" x 50 yds

ROKAMAT



20000

40 Discs Included



ROKAMAT Chameleon Vacuum Power Rasp

- 3 x Faster Rasping
- Dust Removal
- Smoother Finish
- Dual Disc Counter Rotation 100-600 rpm
- Standard 200mm velcro backed paper abrasives
- Lifetime Parts

Item #	Description
20000	Rokamat Chameleon Sander™
KIT-EIFS	Rokamat Vacuum™ EIFS Set

12 GRIT

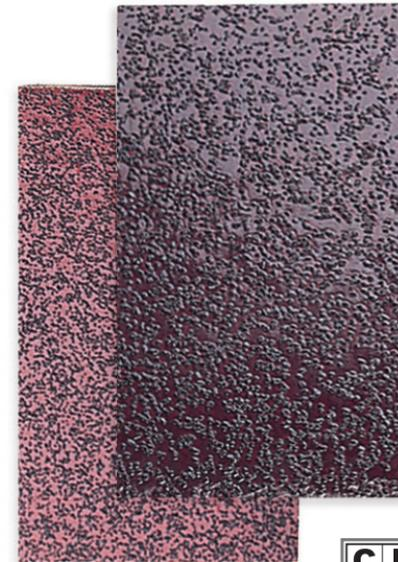

16 GRIT



BRP250 BRP450 BRP650 BRP850

CARVE360™

CORDLESS HOT KNIFE

- 36V / 1.5Ah
- Lithium-Ion Battery Powered
- Full Charge in About an Hour
- Variable Heat Control
- Lightweight



Item #	Description
HKT360	CARVE360™ Cordless Hot Knife
400CR	4" Stamped Blade
600CR	6" Stamped Blade
800	8" Stamped Blade
1000	10" Stamped Blade
HKT360P01	Lithium-Ion Battery
HKT360P02	Battery Charger
HKTCRP01	Blade Adapter

Standard Kit Includes:

CARVE360™, Two Lithium-Ion Batteries, Battery Charger, 4" & 6" Blades, Custom Blade Adapter, Wire Brush, Hex Tool and Carry Case

HKT360



The Custom Blade Adapter makes it easy to use all of the Original Hot Knife™ post style blades.



SCULPTOR'S KIT

CARVE360™ Hot Knife with Extra Long Blades

- CARVE360™ Hot Knife
- 4", 6", 8" & 10" Hot Knife Blades
- 3 Feet NFWF Flat Wire
- Wire Crimping Tool
- Carry Case

Item #	Description
HKT360-A	CARVE360 Sculptor's Kit



CARVE360™ with CR6G Groove Adapter

PRO SCULPTOR'S KIT

CARVE360™ Hot Knife Foam Carving Kit

- CARVE360™ Hot Knife
- 4", 6", 8" & 10" Hot Knife Blades
- Custom Blade Adapter
- 10 Original Hot Knife™ Blades with Stops
- Wire Brush and Hex Tool
- Carry Case

Item #	Description
KITHKK360	CARVE360 Foam Carving Kit



EIFS STARTER KIT

CARVE360™ with 6" Groove Adapter

- CARVE360™ Hot Knife
- 6" Groove Adapter with Guide
- 4" & 6" Hot Knife Blades
- 3 Feet NFWF Flat Wire
- Carry Case

Item #	Description
HKT360-CR6G	CARVE360 with Groove Adapter



PRO EIFS KIT

CARVE360™ Foam Cutter Kit with 6" Groove Adapter

- CARVE360™ Hot Knife
- 6" Groove Adapter with Guide
- 4" & 6" Hot Knife Blades
- 3 Feet NFWF Flat Wire
- Crimping Pliers
- 6" EIFS DuraRasp™
- Heavy Duty Canvas Bag
- Carry Case

Item #	Description
KITPRO360	CARVE360 Foam Cutter Kit



8" & 10" Hot Knife Blades are Available



1000

800

MASTER KIT

CARVE360™ HOT KNIFE WITH EXTRA ACCESSORIES

- CARVE360™ Hot Knife
- 1" Groove Adapter
- 4", 6" & 8" Hot Knife Blades
- Wire Crimping Tool
- Carry Case
- 6" Groove Adapter with Guide
- Angle Cutting Guide
- 2 Feet NFWF Flat Wire
- Wire Brush and Hex Tool

Item #	Description
HKT360-M	CARVE360 Master Kit



COOL CUT™ Air Cooled Hot Knife

- Air Cooled Housing Allows for Continuous Cutting Usage
- 190 Watts
- Includes 4" & 6" Blades and Case
- Electronic Circuit Board Powered
- Variable Heat Control
- Lightweight
- Stamped Blades
- Spring Loaded Safety Trigger

Item #	Description
HKTCC	Cool Cut Knife & Blade Adapter w/ 4" & 6" Blades
200CR	2" Blade
400CR	4" Blade
600CR	6" Blade
HKTCRP01	Blade Adapter



ADJUSTABLE
HEAT DIAL



Custom
Blade
Adapter

HKTCRP01

2", 4" & 6" Blades Available



All of these Custom Blades fit the Cool Cut™ using the Custom Blade Adapter.

1" & 6" GROOVE ADAPTER Grooves Up to 6" Wide

Item #	Description
CR1G	Hot Knife CR™ Groove Adapter
CR1G-M	Hot Knife CR™ 1" Groove Adapter
CR6G	Hot Knife CR™ 6" Groove Adapter
NFWF	Flat Wire, per foot

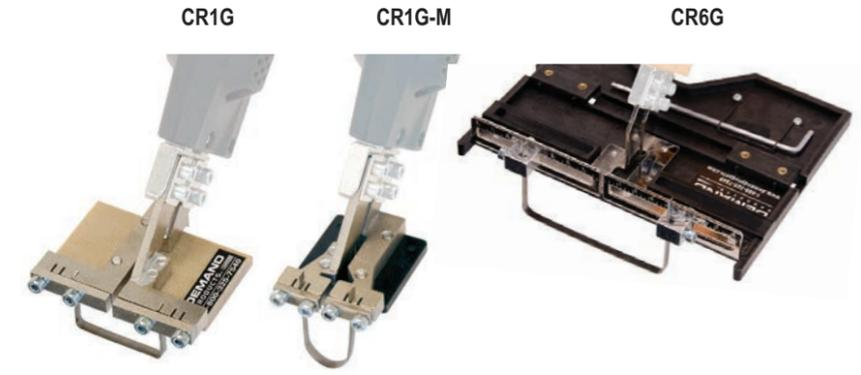

CR ANGLE GUIDE Cut Custom Angles

Item #	Description
CRANGLE	CR Angle Guide



CRIMPING TOOL Precise Bends in NFWF Wire

- Quality Chrome Plated Precision
- 10' of NFWF Wire & Crimping Tool

Item #	Description
WCP	Wire Shaping Tool
KITWCP10	Shaping Tool Kit



KITWCP10

WCP



COOL CUT EIFS STARTER KIT Super Value Saves Money

- Kit Includes:
- Cool Cut™
 - 4" & 6" Blades,
 - 6" Groove Adapter
 - 3 Feet of NFWF Wire and Case

Item #	Description
KITCC6G	Cool Cut Kit



COOL CUT PRO KIT Everything You Need

- Kit Includes:
- Cool Cut™
 - 4" & 6" Blades
 - 6" Groove Adapter
 - 3 Feet of NFWF Wire
 - Crimping Pliers
 - 6" DuraRasp™ and Canvas Bag

Item #	Description
KITPROCC	Cool Cut Pro Kit



MASTER KIT COOL CUT™ Everything In One Kit

- Kit Includes:
- Cool Cut™
 - 2" Curved Blade
 - 1" Groove Adapter
 - Crimping Tool
 - Cleaning Brush
 - 4" & 6" Blades,
 - 6" Groove Adapter,
 - Angle Guide
 - 2 Feet of NFWF Wire
 - Hex Tool and Case

Item #	Description
HKTCC-M	Cool Cut™ Master Kit



HOT KNIFE CR™

Complete with Case

- 190 Watts
- Includes 4" & 6" Blades and Case
- Electronic Circuit Board Powered
- Variable Heat Control
- Lightweight
- Stamped Blades
- Spring Loaded Safety Trigger

Item #	Description
HKTCR	Hot Knife CR™ & Blade Adapter w/ 4" & 6" Blades
200CR	2" Blade
400CR	4" Blade
600CR	6" Blade
800	8" Blade
HDC220	220 Volt Converter
HKTCRP01	Blade Adapter

Heats Up To 12" of Wire



2", 4", 6" & 8" Blades Available

Custom Blade Adapter



HKTCR



All of these Custom Blades fit the Hot Knife CR™ using the Custom Blade Adapter.

ADJUSTABLE HEAT DIAL



Kit Includes:
Hot Knife CR™, 4" & 6" Blades, Custom Blade Adapter, Cleaning Brush and Case

1" & 6" GROOVE ADAPTER

Grooves Up to 6" Wide

Item #	Description
CR1G	Hot Knife CR™ Groove Adapter
CR1G-M	Hot Knife CR™ 1" Groove Adapter
CR6G	Hot Knife CR™ 6" Groove Adapter
NWFW	Flat Wire, per foot

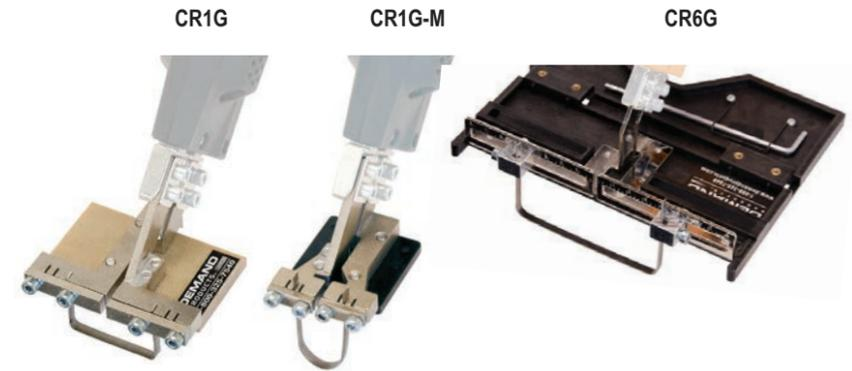

CRIMPING TOOL

Precise Bends in NWFW Wire

- Quality Chrome Plated Precision
- 10' of NWFW Wire & Crimping Tool

Item #	Description
WCP	Wire Shaping Tool
KITWCP10	Shaping Tool Kit

KITWCP10



WCP

CR ANGLE GUIDE

Cut Custom Angles

Item #	Description
CRANGLE	CR Angle Guide



HOT KNIFE CR™ EIFS STARTER KIT

Super Value Saves Money

Kit Includes: Hot Knife CR™, 4" & 6" Blades, 6" Groove Adapter, 3 Feet of NWFW Wire and Case

Item #	Description
KITCR6G	Hot Knife CR™ Kit



HOT KNIFE CR™ PROKIT

Everything You Need

Kit Includes: Hot Knife CR™, 4" & 6" Blades, 6" Groove Adapter, 3 Feet of NWFW Wire, Crimping Pliers, 6" DuraRasp™ and Canvas Bag

Item #	Description
KITPROCR	Hot Knife CR™ Pro Kit



HOT KNIFE CR™ MASTERKIT

Everything In One Kit

Kit Includes:

- Hot Knife CR™
- 2" Curved Blade,
- 1" Groove Adapter
- Crimping Tool
- Cleaning Brush
- 4", 6" & 8" Blades
- 6" Groove Adapter
- Angle Guide
- 2 Feet of NWFW Wire
- Hex Tool and Case

Item #	Description
HKTCR-M	Hot Knife CR™ Master Kit





THE ORIGINAL HOT KNIFE™
From Demand Products

- 105 Watts
- Transformer Powered
- Lightweight - Only 1 Pound
- High Quality Blades with Post Mounts. **Not** Stamped
- Spring Loaded Safety Trigger
- Blades Sold Separately

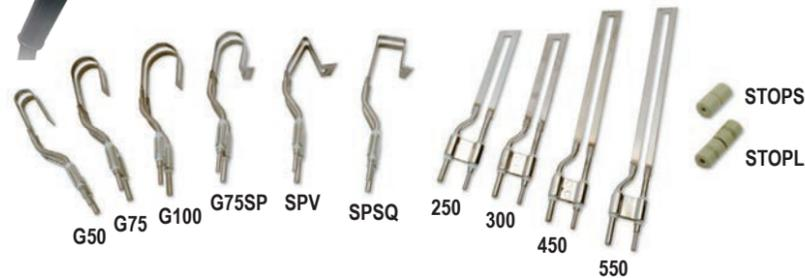

Item #	Description
HKT	Hot Knife™ Tool, 105 Watts
HKT250	Hot Knife™ Tool, w/ 2.5" Blade
HKT300	Hot Knife™ Tool, w/ 3.0" Blade
HKT450	Hot Knife™ Tool, w/ 4.5" Blade
HKT550	Hot Knife™ Tool, w/ 5.5" Blade
HKTG75	Hot Knife™ w/ 3/4" Curved Blade
CASEH	Hot Knife™ Hard Case
CASEA	Hot Knife™ Aluminum Case
HKTT	Hot Knife™ Trade In
HKT20	Hot Knife™ Tool, 220 Volts*
250	2.5" Straight Blade
300	3.0" Straight Blade
450	4.5" Straight Blade
550	5.5" Straight Blade
G50	1/2" Curve Blade
G75	3/4" Curve Blade
G100	1" Curve Blade
G75SP	3/4" Curve Blade w/ Lip
SPV	3/4" V Groove w/ Lip
SPSQ	3/4" Square Groove w/ Lip
STOPS	Short Ceramic Depth Stop
STOPL	Long Ceramic Depth Stop

* INTERNATIONAL TOOL

HOT KNIFE™ ADAPTERS

Horizontal and Vertical Adapters with Guides

- Positions Hot Knife Horizontally or Vertically
- Horizontal Adapter Handles up to 4" of NFWF
- Vertical Adapter Handles up to 6" of NFWF

Item #	Description
GJA4G	Horizontal 4" Groove Adapter
GJA6G	Vertical 6" Groove Adapter
NFWF	Flat Wire, per foot

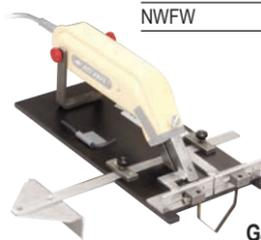

GJA4G

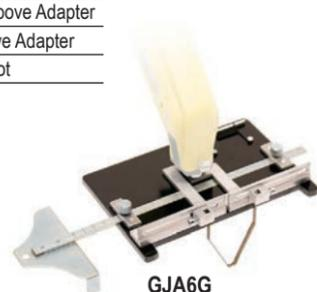

GJA6G

HOT KNIFE™ ADAPTER KITS

Horizontal and Vertical Adapter Kits

Kits Include: Hot Knife™, Groove Adapter, 2' NFWF Wire, 4 1/2" Blade and Carry Case

Item #	Description
KITHKTBA	Tool Buddy™ Horizontal Kit
KITHKTBA4	Kit w/ Aluminum Case
KITHKTBA204	Hot Knife™ Kit, 220 Volts*
KITHKTBA	Tool Buddy™ Vertical Kit
KITHKTBA	Kit w/ Aluminum Case
KITHKTBA20	Hot Knife™ Kit, 220 Volts*

* INTERNATIONAL TOOL



Horizontal Adapter Kit

Vertical Adapter Kit



KITGJ400 with Guide

Wire sold separately

GROOVE JET™ 400 HOT KNIFE
Aesthetic Groove Cutter

- Weighs Only 4 Lbs
- Handles up to 5" x 3" NFWF Blades
- Heats Up Fast
- Cuts Clean with One Pass
- Blade Positioned Up Front
- Available in 220 Volts

Item #	Description
KITGJ400	Groove Jet™ 400
NFWF	Flat Wire, per foot

CUTS ALL THE WAY TO INSIDE CORNERS

GROOVE JET™ CASES

- Tools Not Included

Item #	Description
CASEA	Aluminum Case, 17"w x 5.5"h x 12"d
CASE	Plastic Case, 20"w x 9"h x 8"d



Aluminum Case



Plastic Hard Case



HOT KNIFE™ KIT 1
Master Kit

- Cuts Both Expanded and Extruded Foam
- Cuts Fast, Clean and Accurately
- Heats Up In Seconds
- Highest Quality Blades in the Industry
- Kit Includes: Hot Knife™, 250, 300, 450, 550, G50, G75, G75SP, SPV, G100, SPSQ Blades, Long Stop, Short Stop and Hard Case

Item #	Description
KITHKK	Master Hot Knife™ Kit
KITHKKA	Kit w/ Aluminum Case
KITHKK220	Hot Knife™ Kit, 220 Volts*

* INTERNATIONAL TOOL



GROOVE JET™ KIT
Most Popular Grooving Kit

- GJ400 Groove Jet™
- 10' NFWF Flat Wire
- Carry Case

Item #	Description
KITGJ4K	Groove Jet™ with Hard Shell Case
KITGJ4KA	Groove Jet™ with Aluminum Case



GROOVE TOOL HANDLE & ACCESSORIES

Handle, Custom Blades, Custom Inserts & Blade Kit

AESTHETIC GROOVE KITS

V GROOVE TOOL - BLADES AND SLED KITS

Item#	Dimensions (A and B)
KITV100	1" x 1/2"
KITV101	1" x 1"
KITV150	1-1/2" x 3/4"
KITV175	1" x 3/4"
KITV200	2" x 1"
KITV5050	1/2" x 1/2"
KITV75	3/4" x 3/8"
KITV7575	3/4" x 3/4"

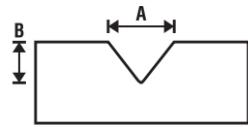

ANGLED GROOVE TOOL BLADES AND SLED KITS

Item#	Dimensions (A, B and C)
KITA102	1" x 1/2" x 1/2"
KITA104	1" x 3/4" x 1/4"
KITA152	1-1/2" x 1/2" x 1"
KITA154	1-1/2" x 3/4" x 3/4"
KITA201	2" x 1" x 1"
KITA202	2" x 1/2" x 1-1/2"
KITA204	2" x 3/4" x 1-1/4"
KITA301	3" x 1" x 2"

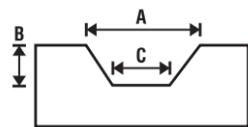

BEVELED GROOVE TOOL BLADES AND SLED KITS

Item#	Dimensions (A, B and C)
KITB102	1" x 1/2" x 3/4"
KITB104	1" x 3/4" x 1/2"
KITB151	1-1/2" x 1" x 7/8"
KITB154	1-1/2" x 3/4" x 1"
KITB201	2" x 1" x 1-3/8"
KITB204	2" x 3/4" x 1-1/2"

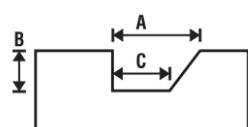

SQUARE GROOVE TOOL - BLADES AND SLED KITS

Item#	Dimensions (A and B)
KITS101	1" x 1"
KITS102	1" x 1/2"
KITS103	1 x 3/4"
KITS151	1-1/2" x 1"
KITS152	1-1/2" x 1/2"
KITS153	1-1/2" x 3/4"
KITS201	2" x 1"
KITS203	2" x 3/4"
KITS502	1/2" x 1/2"
KITS752	3/4" x 1/2"
KITS753	3/4" x 3/4"

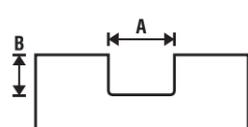

Blades & Inserts Are Not Included with Handle

Item #	Description
GTH03	Groove Tool Handle
GJBCUSTOM	Custom Blade (each)
GTICUSTOM	Custom Insert (each)

*CUSTOM SIZES AVAILABLE



Aesthetic grooves add texture and interest to any stucco/EIFS project.



CR6G Adapter and Hot Knife Sold Separately



Groove Tool Handle Sold Separately

REPLACEMENT BLADES ONLY

V GROOVE - HOT KNIFE BLADES

Item#	Dimensions (A and B)
GBV100	1" x 1/2"
GBV101	1" x 1"
GBV150	1-1/2" x 3/4"
GBV175	1" x 3/4"
GBV200	2" x 1"
GBV5050	1/2" x 1/2"
GBV75	3/4" x 3/8"
GBV7575	3/4" x 3/4"



ANGLED GROOVE - HOT KNIFE BLADES

Item#	Dimensions (A, B and C)
GBA102	1" x 1/2" x 1/2"
GBA104	1" x 3/4" x 1/4"
GBA152	1-1/2" x 1/2" x 1"
GBA154	1-1/2" x 3/4" x 3/4"
GBA201	2" x 1" x 1"
GBA202	2" x 1/2" x 1-1/2"
GBA204	2" x 3/4" x 1-1/4"
GBA301	3" x 1" x 2"



BEVELED GROOVE - HOT KNIFE BLADES

Item#	Dimensions (A, B and C)
GBB102	1" x 1/2" x 3/4"
GBB104	1" x 3/4" x 1/2"
GBB151	1-1/2" x 1" x 7/8"
GBB154	1-1/2" x 3/4" x 1"
GBB201	2" x 1" x 1-3/8"
GBB204	2" x 3/4" x 1-1/2"



SQUARE GROOVE - HOT KNIFE BLADES

Item#	Dimensions (A and B)
GBS101	1" x 1"
GBS102	1" x 1/2"
GBS103	1 x 3/4"
GBS151	1-1/2" x 1"
GBS152	1-1/2" x 1/2"
GBS153	1-1/2" x 3/4"
GBS201	2" x 1"
GBS203	2" x 3/4"
GBS502	1/2" x 1/2"
GBS752	3/4" x 1/2"
GBS753	3/4" x 3/4"



REPLACEMENT INSERTS ONLY

V GROOVE - NYLON INSERTS

Item#	Dimensions (A and B)
GIV100	1" x 1/2"
GIV101	1" x 1"
GIV150	1-1/2" x 3/4"
GIV175	1" x 3/4"
GIV200	2" x 1"
GIV5050	1/2" x 1/2"
GIV75	3/4" x 3/8"
GIV7575	3/4" x 3/4"



ANGLED GROOVE - NYLON INSERTS

Item#	Dimensions (A, B and C)
GIA102	1" x 1/2" x 1/2"
GIA104	1" x 3/4" x 1/4"
GIA152	1-1/2" x 1/2" x 1"
GIA154	1-1/2" x 3/4" x 3/4"
GIA201	2" x 1" x 1"
GIA202	2" x 1/2" x 1-1/2"
GIA204	2" x 3/4" x 1-1/4"
GIA301	3" x 1" x 2"



BEVELED GROOVE - NYLON INSERTS

Item#	Dimensions (A, B and C)
GIB102	1" x 1/2" x 3/4"
GIB104	1" x 3/4" x 1/2"
GIB151	1-1/2" x 1" x 7/8"
GIB154	1-1/2" x 3/4" x 1"
GIB201	2" x 1" x 1-3/8"
GIB204	2" x 3/4" x 1-1/2"



SQUARE GROOVE - NYLON INSERTS

Item#	Dimensions (A and B)
GIS101	1" x 1"
GIS102	1" x 1/2"
GIS103	1 x 3/4"
GIS151	1-1/2" x 1"
GIS152	1-1/2" x 1/2"
GIS153	1-1/2" x 3/4"
GIS201	2" x 1"
GIS203	2" x 3/4"
GIS502	1/2" x 1/2"
GIS752	3/4" x 1/2"
GIS753	3/4" x 3/4"



Custom orders available. See order form at demandproducts.com

Custom orders available. See order form at demandproducts.com

HOT ROD™

Super Duty 50 Amp EPS Panel Cutter

- Strongest In The Industry
- Cuts All Day Long Without Overheating
- Uses Heavy Gauge Round and Flat Wire As Well As Standard Hot Knife Blades
- Variable Heat Control — Heats Up Extremely Fast
- Remote HD Transformer with Extra Long 9' Cable
- Excellent for SIP's, ICF, EIFS or In-Plant Production Applications
- Heats NFW Wire From 8" to 24"
- 110 Volts. Also Available in 220 Volts



Light Gauge Wire Only

NW500 NW100

Heats Ni-Chrome Wire 24" to 53"
Hot Enough To Cut EPS Foam



MADE IN THE USA

GEO 8' FOAM HOT WIRE KIT

Free-Hand Cutting

- Hot Wire Handles
- Magnum Controller
- From 24" to 108"
- 100 Foot Roll of Ni-Chrome Wire
- Carrying Case



APC CONTROLLER

Use with Shape Wire

- Uses Heavy Gauge Wire Only
- Heats 1'-3' of NFW or NWRW11 / 16 Wire

Item #	Description
APC	Auxiliary Power Controller

MAGNUM™ CONTROLLERS AND WIRE

- Uses Light Gauge Wire Only
- Designed to Heat Appropriate Length of Wire to Cut EPS Foam

Item #	Description
MAGNUM	2' - 8' Magnum Power Controller
NW100	Ni-Chrome Wire, 100' (.02265)
NW500	Ni-Chrome Wire, 500' (.02265)

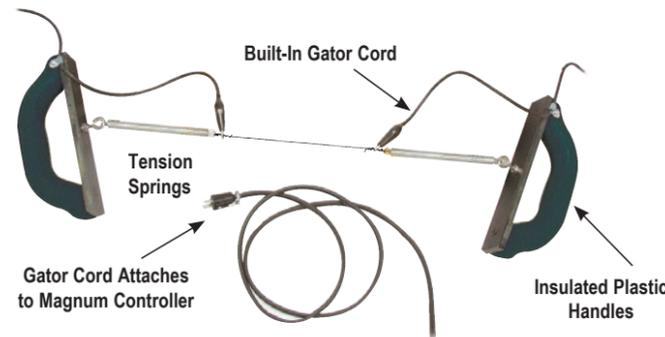

HOT WIRE HANDLES

Free-Hand Cutting

Item #	Description
HWH	Hot Wire Holders (Set of 2)
MAGNUM	2' - 8' Magnum Power Controller
NW100	Ni-Chrome Wire, 100' (.02265)
KITHWH8	HWH & 2' - 8' Magnum w/ NW100 Wire
HWHHP06	HWH Spring, each

HOT WIRE KIT

Do-It-Yourself Kit

- Everything You Need to Build Your Own 2' - 8' Hot Wire Machine
- Magnum Controller
- Gator Cord
- 2 Insulators
- Spring
- 100' Roll of Wire



Item #	Description
KITHW	2' - 8' Hot Wire Kit
ULP200	4' Wide Gator Cord Only
ULP400	8' Wide Gator Cord Only
ULP01	Insulator
SCP00	Spring

Kit includes Magnum Controller, Gator Cord, 2 Insulators, Spring and 100' Roll of Wire



Item #	Description
*HR	Hot Rod™ Only, 110 Volts (60 Hertz)
KITHRK	Hot Rod™ Kit Includes * Items Below
*250	2 1/2" Straight Blade
*300	3" Straight Blade
*450	4 1/2" Straight Blade
*550	5 1/2" Straight Blade
*600CR	6" Straight Blade (Open Mount)
*800	8" Straight Blade (Open Mount)
*1000	10" Straight Blade (Open Mount)
*G50	1/2" Curve Blade
*G75	3/4" Curve Blade
*G100	1" Curve Blade
*G75SP	3/4" Curve Blade with Lip
*SPV	3/4" V Blade with Lip
*SPSQ	3/4" Square Groove with Lip
*HRP10	Hot Rod™ Blade Adapter
*STOPS	Short Ceramic Stop
*STOPL	Long Ceramic Stop

HR220	Hot Rod™ Tool Only, 220 Volts (50 / 60 Hertz)
KITHRK220**	Hot Rod™ Kit, 220 Volts (50 / 60 Hertz)

* INCLUDED IN KIT
** INTERNATIONAL TOOL

HOT ROD™ GROOVE ADAPTERS

2 Convenient Sizes with Guides

- Excellent for SIP's, ICF or EIFS
- Great for In-Plant Production Applications

Item #	Description
GJA6G	6" Groove Adapter
GJA10G	10" Groove Adapter
NFWF	Flat Ni-Chrome Wire - Per Foot



CORD AND HANDLE

Hot Rod™ Replacement Cord and Handle

Item #	Description
HRP02	Hot Rod™ Cord and Handle



HOT ROD™ BLADE ADAPTER

Item #	Description
HRP10	Hot Rod™ Blade Adapter

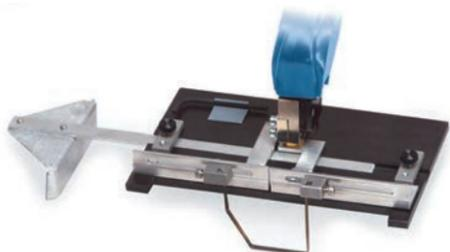

GJA6G Adapter 6" Blade Width

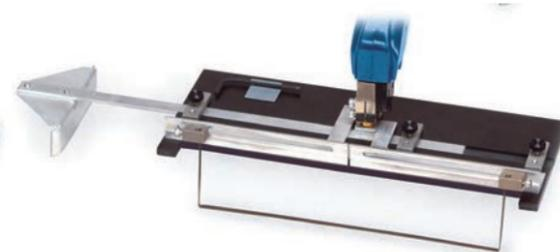

GJA10G Adapter 10" Blade Width



SIP GROOVER
SIP Panel Groove Tool

- Weighs Only 2 Lbs
- Long HD Cord
- Heavy Commercial Construction
- Adjustable Depth Guide

Item #	Description
SIPG114	1 1/4" SIP Groove Tool
SIPG312	3 1/2" SIP Groove Tool
SIPG412	4 1/2" SIP Groove Tool
SIPG512	5 1/2" SIP Groove Tool
SIPG714	7 1/4" SIP Groove Tool
SIPG914	9 1/4" SIP Groove Tool
SIPG1114	11 1/4" SIP Groove Tool
CASE	SIP Groover Case



SIP Groover is designed to work with EPS foam only. Do not use with Polyurethane.

NOTE: Custom Sizes Available



INSUL-KNIFE
Multi- Purpose Foam Insulation

- Cut Foam insulation board with precision and no mess
- Cut fiberglass insulation with ease
- Trim expanded foam insulation around windows and doors
- Cut pipe insulation, sponge foam, and much more

Item #	Description
INSULKNIFE	Insul-Knife



KITICF2

PRO KIT

Includes: Original Hot Knife™, 450 Blade, 4" Hot Knife Adapter, 2' NFWF Flat Wire, Cable Slot Cutter (3-Pak), Single Electrical Box Cutter (3-Pak), Double Slot Cutter (3-Pak), HD Canvas Bag, 3/4" Cutting Knife.

Item #	Description
KITICF2	ICF Kit

BOW CUTTER 48™
48" Free-Form Cutter

- Available With or Without Magnum Power Supply
- Uses NW100 Wire

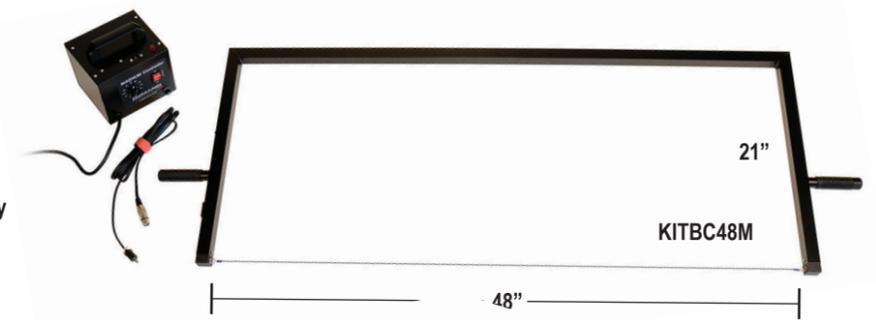

BOW CUTTER 24™
24" Free-Form Cutter

- Available With or Without Magnum Power Supply
- Uses NW100 Wire

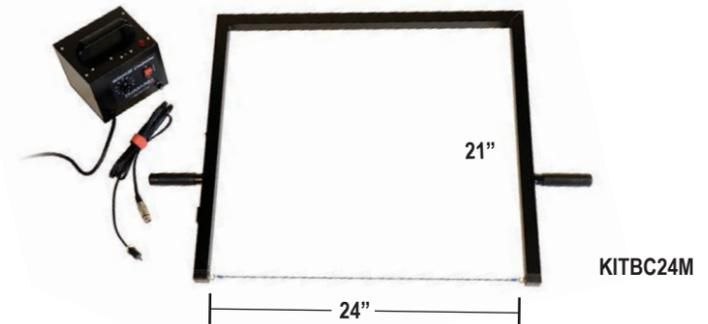

See Page 25 for Magnum Controllers

BOW CUTTER 12™
12" Free-Form Cutter

- Features Built In Power Supply
- Uses NW100 Wire
- Cordless

BowCutter 12™ comes complete with power controller.

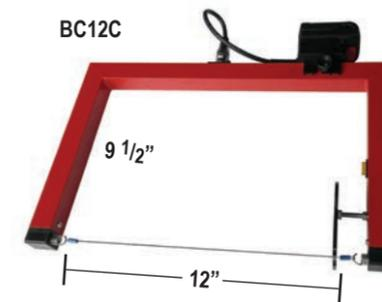

Item #	Description
BC48	48" Bow Cutter Only
MAGNUM	Magnum Power Controller
KITBC48M	48" Bow Cutter with Magnum
BC24	24" Bow Cutter Only
KITBC24M	24" Bow Cutter with Magnum
BC12C	12" Bow Cutter with Controller
NW100	Ni-Chrome Wire, 100 Feet
NW500	Ni-Chrome Wire, 500 Feet

WALL SKINNER™
Shaves EPS High Spots

- Eliminates EPS Dust
- Reduces Rasping
- Levels Walls to Perfection

Item #	Description
WS48	48" Wall Skinner Only
MAGNUM	Magnum Power Controller
KITWS48M	48" Wall Skinner with Magnum
NW100	Ni-Chrome Wire, 100 Feet
NW500	Ni-Chrome Wire, 500 Feet

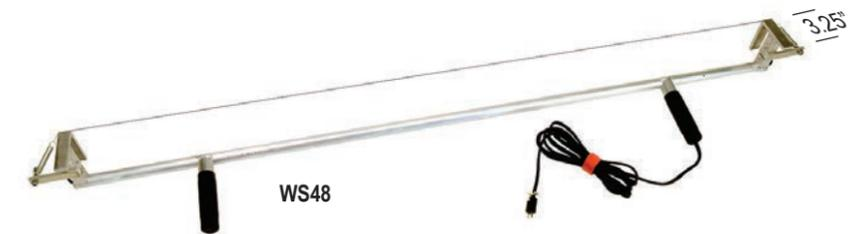

KITWS48M includes Magnum Controller

See Page 25 for Magnum Controllers

CARVE360™ ICF STARTER KIT
Hot Knife Foam Cutter Tool Kit

Includes: CARVE360™ Hot Knife, 4" & 6" Hot Knife Blades, 6" Groove Adapter with Guide, 2 Feet NFWF Flat Wire, 3 ICF Cable Slot Cutters, 3 ICF Single Electrical Box Cutters, 3 ICF Double Electrical Box Cutters, Heavy Duty Tajima Utility Knife, Carry Case

Item #	Description
KITICF360	CARVE360 ICF & SIPS Tool Kit

CUTRITE™ ICF STARTER KIT
Hot Knife Foam Cutter Tool Kit

Includes: The Hot Knife CR™ Foam Cutter, 450 Blade, 4" Hot Knife Adapter, 2' of NFWF Flat Wire, 3 ICF Cable Slot Cutters, 3 ICF Single Electrical Box Cutters, 3 ICF Double Electrical Box Cutters, Heavy Duty Hard Case, Heavy Duty Tajima Utility Knife

Item #	Description
KITICFCR2	CUTRITE ICF & SIPS Tool Kit



KITICF360



KITICFCR2

STYROSMITH™ 2-in-1 Hot Wire Foam Cutter and Ornamental Shaper

- Ornamental Shapes
- Vertical & Horizontal Straight Cuts
- Channels, Angles, Tapers, Compound Miters, Straight Cuts, Columns, Decorative Moldings, etc.
- 110 Volt
- 24" Block Table Capacity
- Auxiliary Table
- Weighs Just 225 Lbs

Item #	Description
KITSS	StyroSmith™ Only
MAGNUM	Magnum Power Controller
KITSSM	StyroSmith™ with Magnum
NW100	Ni-Chrome Wire, 100 Feet
NW500	Ni-Chrome Wire, 500 Feet



KITSSM

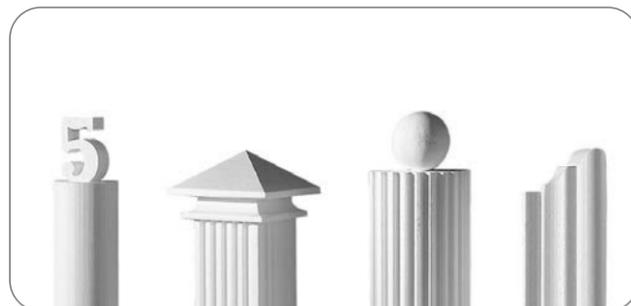
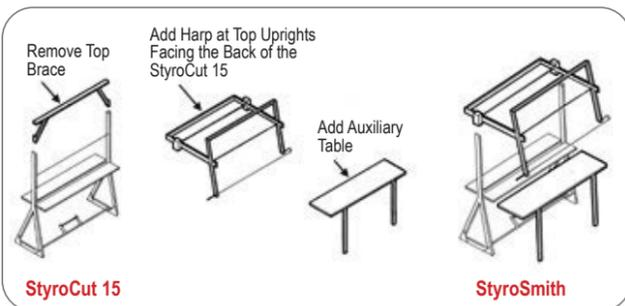

STYROCUT™ Our Best Machine!

- Use In-Plant or On Job Site
- Foot Pedal Control
- Designed by Engineers To Cut Straight, Channel, Angles and Tapers
- Portable — Weighs Just 117 Lbs
- Capable of Vertical and Horizontal Cuts
- Table Tilts and Locks 0° - 45°
- Cuts 15" Deep x 4' Wide
- Cutting Table is 60" Wide x 27" Deep

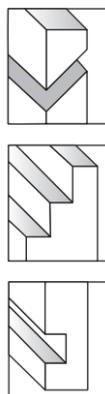

Item #	Description
KITSC	StyroCut™ Only
MAGNUM	Magnum Power Controller
KITSCM	StyroCut™ with Magnum
NW100	Ni-Chrome Wire, 100 Feet
NW500	Ni-Chrome Wire, 500 Feet



KITSCM

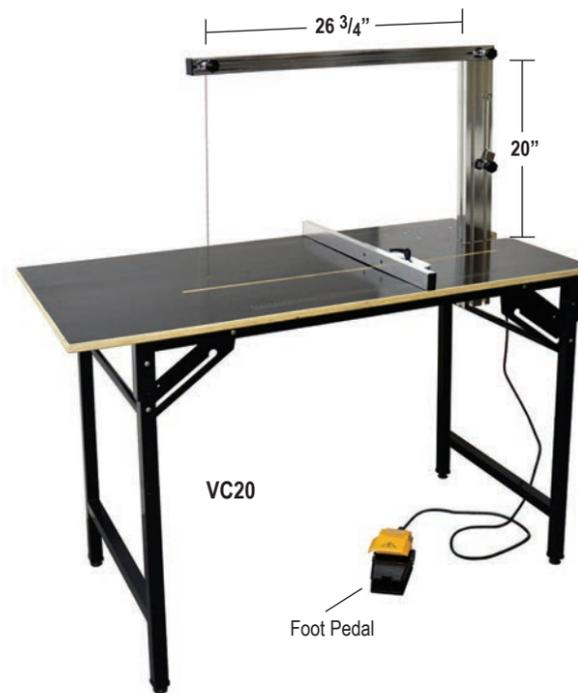

VC20

Foot Pedal

VERTI-CUTT™ Hot Wire Foam Cutter

- Portable — Weighs only 60 Lbs
- Sets Up and Folds Down in Seconds
- For Vertical and Diagonal Cuts
- Cuts Corners and Cylinders
- Moisture Resistant Bakelite Table Top
- Built In Power Supply Mounts Under Table
- Continuously Adjustable Temperature
- Heats Wire in 10-15 Seconds

Item #	Description
VC20	Verti-Cutt™ with Power Supply
NW100	Ni-Chrome Wire, 100 Feet
NW500	Ni-Chrome Wire, 500 Feet



Built In Transformer



Diagonal Cuts



Bevel Cuts



KITSWM

SIDEWINDER™ Ornamental 4' Shape Cutter

- Cuts Compound Miters, Angle Straight Cuts, Columns, and Decorative Moldings
- Uses Your Hardboard Template Patterns to Trace Shapes
- Variable Heat Control — Heats Up Extremely Fast
- 110 Volts, Also Available in 220 Volts
- 2' x 4' Block Table Capacity
- 33" x 62" Wide Table Size
- Weighs Just 125 Lbs
- Cuts 48" Wide EPS

Item #	Description
KITSW	SideWinder™ Only
MAGNUM	Magnum Power Controller
KITSWM	SideWinder™ with Magnum
NW100	Ni-Chrome Wire, 100 Feet
NW500	Ni-Chrome Wire, 500 Feet



NW500

NW100

Heats Ni-Chrome Wire 24" to 53"
Hot Enough To Cut EPS Foam



TRIMIXX™ Commercial Duty, 3-Position Production Mixer

- Designed for Mixing and Blending Industrial Coatings
- Powered by Three 3/4 Horsepower Motors with a 5:1 Ratio Transmission
- Emergency Stop Button for Each Motor
- Carriage Can be Positioned at Any Height
- 345 RPM, 230 Volts / 60Hz, 16 Amps
- Safety Foot Switch
- Comes Complete with Roller Conveyor
- Quick-Disconnect Chucks
- Counter Balance Carriage
- Three M819 Mixing Paddles
- Bucket Locking Mechanism
- Super Heavy Duty Ball Bearing Motors
- Heavy Duty Production Roller Conveyor

Item #	Description
TMIXX	TriMixx™ Mixer



MIXX-ALL 401 Variable Speed Super Duty EIFS / Stucco Mixer

- 3/4 Horse Power Electric Motor
- Variable Speed, 0-660 RPM
- 110 VAC (90 VDC)
- 3/4" Chuck
- Counter Balanced for Smooth Operation

Item #	Description
MX401	Mixx-All Mixer



MAKITA™ ELECTRIC MIXER

- 1/2" Spade Handle
- 0-600 RPM
- 6.5 Lbs
- 8.5 Amps, 120 Volt



Item #	Description
M7564	Electric Mixer

Variable
Speed
Control

MIXING PADDLES Professional Quality Mixing Paddles

- Designed for Mixing and Blending Industrial Coatings
- No Plastic Coatings to Flake Off In Material
- Heavy Duty Construction

Item #	Description
M713	Paddle, 8 1/2" x 5" x 30" (Aluminum)
M540	Eggbeater Mixer, 5" x 30" (Plated Steel)
M819	Quick Mix, 8 1/2" x 5" x 36" (Steel)
M630	Twister Mixer, 7 1/2" x 30" (Stainless Steel)
M636	Twister Mixer, 7 1/2" x 36" (Stainless Steel)
M525	Speedy Mixer, 6 1/4" x 30" (Galvanized)



NEW Bucket Saving Design

RACER™

Camel-Back Handles with Comfort-Grip



Rubber Comfort-Grip Cork Comfort-Grip

Steel technology makes our Racer™, the EIFS industries "New Choice", when choosing a trowel. Made from German Steel and polished to a flawless smooth finish, Racer™ is the trowel to get the job done. Precision balanced and anchored to a riveted steel tang—for added strength and stability, the Racer™ is light weight and easy to handle.

RACER™ TROWEL SERIES German Stainless Steel Trowels

- Smooth Plate Underside
- No Rivets—No Grinding Marks
- Broken-in Edges & Square Corners Eliminates Line & Ripple Marks
- Camel Back Comfort Grip
- Precision Balanced
- Riveted Steel Tang
- Flexible Blade—German Stainless Steel
- Exposed Rivets—Superior Strength

Item #	Description
DPR512C	4 3/4" x 12" Cork Handle
DPR513C	4 3/4" x 13" Cork Handle
DPR514C	4 3/4" x 14" Cork Handle
DPR516C	4 3/4" x 16" Cork Handle
DPR512R	4 3/4" x 12" Rubber Handle
DPR513R	4 3/4" x 13" Rubber Handle
DPR514R	4 3/4" x 14" Rubber Handle
DPR516R	4 3/4" x 16" Rubber Handle



DURAFLEX GS TROWEL PermaShape® Golden Stainless Steel by Marshalltown™

- PermaShape® Guarantees Trowel Will Maintain Original Flat Shape
- Golden Stainless Steel
- Just Like a Curry

Item #	Description
T512PS	5" X 12"
T513PS	5" X 13"
T514PS	5" X 14"
T516PS	5" X 16"

GOLDEN STAINLESS STEEL TROWEL by Marshalltown™

Item #	Description
T512M	5" X 12"
T513M	5" X 13"
T514M	5" X 14"
T516M	5" X 16"

- Wood Camel Handle
- Golden Stainless Steel



STAINLESS POOL TROWEL by Marshalltown™

Item #	Description
TP516	4 1/2" X 16"



CORK HANDLE GOLDEN STAINLESS STEEL TROWELS

Kraft Elite Series Five Star Trowels

- NEW Precision Ground Edge - Ready for Immediate Use
- Greater Flexibility & Durability to Reduce Fatigue
- Power Pin Rivets for Exceptional Strength
- Unique, Lightweight No Turn Handle
- Trowel Holder for Edge Protection
- Made in USA

Item #	Description
T512C	5" x 12" Cork Handle Trowel
T513C	5" x 13" Cork Handle Trowel
T514C	5" x 14" Cork Handle Trowel
T516C	5" x 16" Cork Handle Trowel



Also Available with Leather, ProForm® or Laminated Hardwood Handles



NOTCHED STAINLESS STEEL TROWELS

- Dura-Soft™ Handle
- Accurately Notched to EIFS Manufacturer's Specifications
- 7 Shapes to Choose From
- Highest Quality Stainless Steel

Item #	Description
TRNT3	Rounded, 3/8" x 1/2" x 1 1/2"
TRNT4	Rounded, 1/2" x 1/2" x 2"
TRNT9	Rounded, 5/8" x 5/8" x 1"
TRNT10	Rounded, 5/16" x 5/16" x 3/4"
TRNT11*	Square, 3/8" x 3/8" x 3/8"

TRNT4	Rounded, 1/2" x 1/2" x 2"	TRNT3	Rounded, 3/8" x 1/2" x 1 1/2"
TRNT10	Rounded, 5/16" x 5/16" x 3/4"	TRNT11*	Square, 3/8" x 3/8" x 3/8"
TRNT9	Rounded, 5/8" x 5/8" x 1"	Dimensions are: Width x Depth x Spread * Carbon Steel	

PERMASHAPE GOLDEN STAINLESS TROWEL

by Marshalltown™

- Dura-Soft™ Handle
- Golden Stainless Steel

Item #	Description
T512DS	5" X 12"
T513DS	5" X 13"
T514DS	5" X 14"
T516DS	5" X 16"

VENETIAN PLASTERING TROWEL

- Soft Handle
- Rounded Corners
- Stainless Steel



Item #	Description
VPT37	3" X 8"

HAND-MADE INOX VENETIAN PLASTERING TROWEL

- Soft Handle
- Rounded Corners
- INOX Stainless Steel



* Additional Sizes Available

Item #	Description
VPT49	3.9" X 9.5"

STAINLESS OUTSIDE CORNER EDGERS

5 Sizes of Detailed Corner Edgers

Leaves a Professional Clean Edge



Item #	Description
T609	1/2" Stainless OUTSIDE Corner Edge
T610	3/4" Stainless OUTSIDE Corner Edge
T611	1" Stainless OUTSIDE Corner Edge
T612	1 1/2" Stainless OUTSIDE Corner Edge
T613	2" Stainless OUTSIDE Corner Edge
KITOC	OUTSIDE Corner Edger Kit (All 5)

STAINLESS INSIDE CORNER EDGERS

5 Sizes of Detailed Corner Edgers

Leaves a Professional Clean Edge



Item #	Description
T599	1/2" Stainless INSIDE Corner Edge
T600	3/4" Stainless INSIDE Corner Edge
T601	1" Stainless INSIDE Corner Edge
T602	1 1/2" Stainless INSIDE Corner Edge
T603	2" Stainless INSIDE Corner Edge
KITICE	INSIDE Corner Edger Kit (All 5)



ALUMINUM HAWKS

Wood or Soft Grip Handle

Item #	Description
TAH132S	Aluminum Hawk, 13 1/2" x 13 1/2" ALUMINUM: SOFT HANDLE
TAH13	Aluminum Hawk, 13" x 13" ALUMINUM: WOOD HANDLE
TAH132	Aluminum Hawk, 13 1/2" x 13 1/2" ALUMINUM: WOOD HANDLE
TAH14	Aluminum Hawk, 14" x 14" ALUMINUM: WOOD HANDLE

MAGNESIUM HAWKS

Wood or Soft Grip Handle

Item #	Description
TMH13S	Magnesium Hawk, 13" x 13" MAGNESIUM: SOFT HANDLE
TMH14S	Magnesium Hawk, 14" x 14" MAGNESIUM: SOFT HANDLE
TMH13	Magnesium Hawk, 13" x 13" MAGNESIUM: WOOD HANDLE
TMH14	Magnesium Hawk, 14" x 14" MAGNESIUM: WOOD HANDLE

COMPOSITE HAWK

Unique Design Especially for EIFS

- Designed Especially for EIFS
- Won't Warp or React to Caustic Materials
- Dura-Soft™ Handle
- Sponge Collar to Prevent Calluses
- Made of a Unique Composite Material
- 12" x 12" Platform

Item #	Description
TCH12	Composite Hawk



NEW!

The New Choice of Master Tradesmen



German Design Technology is the genesis for the Titan™ Trowel Series. Tested in Europe with tool designers and masonry tradesmen for durability, flex and performance—the consensus is, Titan receives “top marks”. The Titan™ is well balanced, providing the right flex and the ergonomic comfort grip is the right fit—particularly on long jobs

TITAN™

Finishing Trowels - German Steel

- Perfectly Smooth Blade Face Crafted from German Steel
- Our ‘Positive’ Flex Helps to Keep your Material Smooth
- Lightweight Design Reduces Fatigue
- Comfort-Grip™ Handle
- Available in Three Industry-Standard Sizes 12”, 13” and 14”

Item #	Description
DPT512	Titan™ Finishing Trowel, 5" x 12"
DPT513	Titan™ Finishing Trowel, 5" x 13"
DPT514	Titan™ Finishing Trowel, 5" x 14"

STAINLESS MARGIN TROWELS

3 Sizes

- Clean Sharp Edges
- Stainless Steel Construction

Item #	Description
TS1	Stainless Margin Trowel, 1 1/2" x 3 3/8"
TS2	Stainless Margin Trowel, 2" x 5 1/2"
TS3	Stainless Margin Trowel, 1 1/2" x 7"
KITTS	All 3 Sizes in Kit (1 Each)

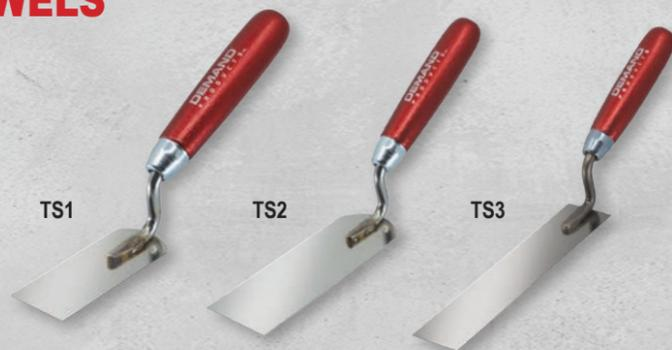

STAINLESS DETAIL TROWELS

2 Sizes — Pointed & Rounded

- The Perfect Pair to Buy
- Stainless Steel Construction

Item #	Description
TPD1	Stainless Pointed Detail Trowel
TRD2	Stainless Rounded Detail Trowel



MARGIN TROWELS

Wood Handles

Item #	Description
T515	Margin Trowel, 1 1/2" x 5"
T520	Margin Trowel, 2" x 5"
T530	Margin Trowel, 2" x 6"
T535	Margin Trowel, 2" x 8"
KITMT	All 4 Sizes in Kit



ALUMINUM HAWKS

Wood or Soft Grip Handle

Item #	Description
TAH132S	Aluminum Hawk, 13 1/2" x 13 1/2"
TAH13	Aluminum Hawk, 13" x 13"
TAH132	Aluminum Hawk, 13 1/2" x 13 1/2"
TAH14	Aluminum Hawk, 14" x 14"

MAGNESIUM HAWKS

Wood or Soft Grip Handle

Item #	Description
TMH13S	Magnesium Hawk, 13" x 13"
TMH14S	Magnesium Hawk, 14" x 14"
TMH13	Magnesium Hawk, 13" x 13"
TMH14	Magnesium Hawk, 14" x 14"

COMPOSITE HAWK

Unique Design Especially for EIFS

Item #	Description
TCH12	Composite Hawk



ALUMINUM HAWK

Wood or Soft Grip Handle

Item #	Description
TAH10	Wood Handle 10" x 10"
TAH10S	Soft Handle 10" x 10"
TAH12	Wood Handle 12" x 12"
TAH12S	Soft Handle 12" x 12"

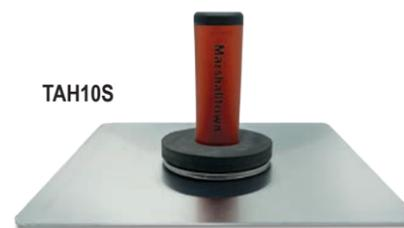

MAGNESIUM HAWK

Wood or Soft Grip Handle

Item #	Description
TMH10	Wood Handle 10" x 10"
TMH10S	Soft Handle 10" x 10"
TMH12	Wood Handle 12" x 12"
TMH12S	Soft Handle 12" x 12"



TUCK POINTERS

Wood or Soft Grip Handle

Item #	Description
TUCK6316	Wood Handle 6 1/2" x 3/16"
TUCK614	Wood Handle 6 1/2" x 1/4"
TUCK6316S	Soft Handle 6 1/2" x 3/16"
TUCK614S	Soft Handle 6 1/2" x 1/4"

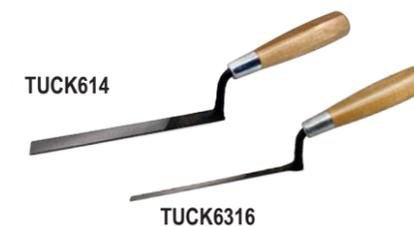

RUB BRICK

Great for Hardened Stucco

Item #	Description
RB631	Rub Brick 6" x 3" x 1"

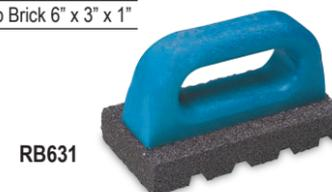

BRUSHES

Quality Brush Products

Item #	Description
B302	Acid Brush with 8" Handle
B403	Tampico Brush with 20" Handle



PRIVATE LABEL PROGRAM

Special Chemical Resistant Labels Outlast Printed and Stamped Style Labels.

Available in 24 Colors



Mix & Match Any Floats on Pages 44 & 45

1" x 3" Custom Label
One Time Minimum Order of 120 Floats



F600 ABS FLOAT

- Solid-Grip Comfort Textured Handle
- 5" x 12"
- ABS Plate

Item #	Description
F600	ABS Float



NEW F-TAN FLOAT

Item #	Description
FTAN-11	Tan Float

- 5" x 11"
- ABS Plate
- Ergonomic Non-Slip Handle



STUCCO SPONGE FLOAT

3/4" and 1" Thickness

- Ideal for Bringing Aggregate to the Surface
- The Most Popular for All Stucco Applications
- 12" x 5" with Wood Handle

Floats

Item #	Description
F125	3/4" Fine Pad
F130	1" Fine Pad
F135	1" Coarse Pad

Replacement Pads

Item #	Description
GPAD6	3/4" Fine Pad, 6 Pack
GPAD61	1" Fine Pad, 6 Pack
GPAD6C	1" Coarse Pad 6 Pack



F400 ROUNDED EDGE FLOAT

Item #	Description
F400	Rounded Edge

- America's Favorite
- Tapered Coned Handle
- Rounded Corners
- 5" x 11"



F300 ROUNDED NEOPRENE FLOAT

Item #	Description
F300	Neoprene Float

- 4" x 12"
- Neoprene Plate



F450 LUCKY GREEN FLOAT

Item #	Description
F450	Lucky Green Float

- 5 1/2" x 11"
- ABS Plate

F150 WHITE SPONGE FLOAT
1" Soft Texture

Item #	Description
F150	White Sponge Float
WPAD6	Replacement Pads 6 Pack

- Retains Water and Provides a Smoother Finish
- 5" x 12" with Wood Handle



F400R NKI FLOAT

Item #	Description
F400R	NKI Float
KITF400R-6	Qty 6 F400R's

- 5" x 11"
- ABS Plate



F650 NKI FLOAT

Item #	Description
F650	NKI PVC Soft Grip

- 5 1/2" x 11"
- PVC Plate



F800 Italian Finish Float

Item #	Description
F800	Italian Float

- 5" x 11"
- PVC Plastic Plate



F850 Italian Finish Float

Item #	Description
F850	Italian Float

- 2" x 11"
- PVC Plastic Plate

F250 TEXTURE FLOAT
Texture Pattern Face

Item #	Description
F250	Texture Float

- 5 1/2" x 11"



FT511 COMPOSITE FLOAT/TROWEL
by Marshalltown

Item #	Description
FT511	Float / Trowel

- Comfortable Contour Wood Handle
- Composite Plate
- 5" x 11"



F500 RIB FLOAT
Stiffer Than Normal

Item #	Description
F500	Rib Float

- 5 1/2" x 11 3/4"
- Ribs Make Plate a Little Stiffer Than Normal



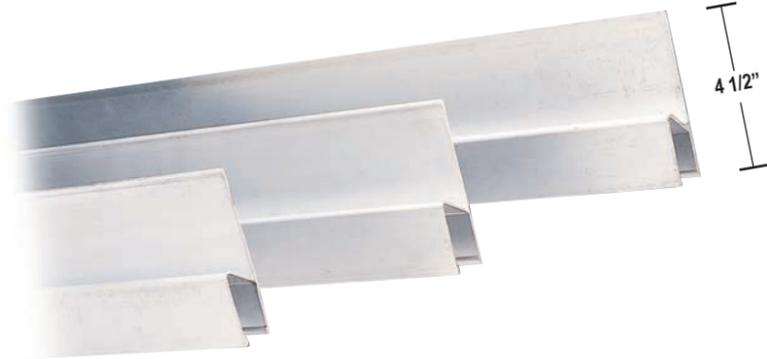

"h" Darbies
Smoothly Levels Hard Coat
Over Long, Straight Areas

Item #	Description
AD4	4' Aluminum Darby
AD6	6' Aluminum Darby
AD8	8' Aluminum Darby

Item #	Description
MD4	4' Magnesium Darby
MD6	6' Magnesium Darby
MD8	8' Magnesium Darby

**STUCCO
SCRATCH-COAT RAKES**

Your Choice of Two Handles

- High Quality Tension Steel

Item #	Description
SRAKE	Stucco Rake - Sculpted Handle
SRAKESG	Stucco Rake - Soft-Grip Handle

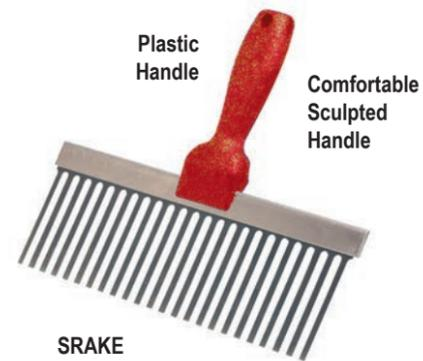

BRUSHES
Quality Brush Products

Item #	Description
B302	Acid Brush with 8" Handle
B403	Tampico Brush with 20" Handle
TB	6" Tampico Bucket Brush (Plastic)
TBR	6" Tampico Bucket Brush (Wood)



RUB BRICK
Great for Hardened Stucco

Item #	Description
RB631	Rub Brick 6" x 3" x 1"



Tajima™
Since 1909

SOFT GRIP KNIVES
Professional Quality
3/4" or 1" Blades

Item #	Description
LC34	3/4" Soft Grip
LC1	1" Soft Grip



TAJIMA™ KNIVES
Economy Breakaways

- Available in 3/4" & 1"
- Great Quality for Demanding Craftsman
- Comfortable Colorful Handles

Item #	Description
T2	Heavy-Duty Knife, 3/4"
T10	10-Pack Blades, 3/4"
T50	50-Pack Blades, 3/4"
D1	Xtra-Heavy-Duty Knife, 1"
D10	10-Pack Blades, 1"
D20	20-Pack Blades, 1"



OLFA™ KNIVES
Breakaways

- Best Breakaway Knives You Can Buy!
- 2 Sizes : 3/4" & 1"
- Distinctive Color Aids Visibility

Item #	Description
L2	Olfa™ 3/4" Heavy Duty Knife
L5	Olfa™ 5-Pack Blades, 3/4"
LB	Olfa™ 50-Pack Blades, 3/4"
H1	Olfa™ 1" Xtra-Heavy-Duty Knife
HP	Olfa™ 5-Pack Blades, 1"
HB	Olfa™ 20-Pack Blades, 1"
LWB	Olfa™ 3-Pack Serrated Foam Blades, fits L2, T2 & LC34



SOFT GRIP KNIVES
Professional Quality 1" Blade

- 25% Sharper
- High Quality Japanese Carbon Tool Steel
- Double Honed Edge

Item #	Description
H1HS	1" Soft Grip
HBB20	Olfa 20-Pack Blades, 1"





Medium Duty

Removes Lid Without Damage

LEVERAGE PRY LIFTER TOOL

Medium Duty

- Lifts Lids Easily with Leverage
- Metal with Plastic Coated Handle
- Does Not Damage Seal

Item #	Description
LLB	11" Long

LEVERAGE PRY BAR

Convenient Size

- Cuts, Seals, Lifts
- 16" Long

Item #	Description
LLH	16" Long



Heavy Duty

LEVERAGE PRY LIFTER TOOL

LIGHT DUTY PLASTIC LID LIFTER

8 1/2" Long

Item #	Description
LL	8 1/2" Long



NEW & IMPROVED

BALTIC SCOOP

Scoop Trowel Tool

- Stronger, Galvanized Steel Keeps from Buckling or Bending
- Sturdier Handle Construction
- Bucket Hanging Clip for Easy Storage
- Measures: 13" long x 7.5" dia. (top) x 3" pan height

Item #	Description
TBSH7	Baltic Scoop



BUCKET TROWEL

European Standard

- New Neck Design Increases Quantity of Material per Scoop
- New Neck Improves Control and Stability
- High Quality Stainless Tapered Scoop
- Flat Surface Wipes Clean

Item #	Description
T700	Bucket Trowel - Wood Handle
T700SG	Bucket Trowel - Soft Grip Handle

New Straight Neck Design

HAND SPRAYERS

HOPPER GUN

2 Gallon Capacity

Sprays: Mill Mixes, Acoustics, Drywall Mud, Glitter, Waterproofing, EIFS and More.

Item #	Description
HG1	Superior Hopper Gun w/ 3 Tip, 2 gal.
KITLMT468	4,6,8 mm Spray Tips & Brass Collar



SPLATTER STUCCO MACHINE

2 Quart Capacity

- Used to Apply Color Coat, Acoustic and Drywall Mud
- Lightweight and Durable
- Can Match Most Surfaces
- 2 Quart Capacity

Item #	Description
SSM2	Stucco Machine



STUCCO SPRAY HOPPER GUN

4 Hole Model

- Hopper Made From Stainless Steel Material
- Lifetime Anti-rust Guarantee
- Slide Out 4 Hole Spray Tip Plate
- 4 Removable Stainless Steel Air Jet Nozzles
- Swivel Between Handle and Hopper For Easy Install

Air compressor information: We recommend to use 12 CFM @ 100 PSI gas power air compressor or electric with 30 gallons or larger air tank.

Item #	Description
HG5	Stucco Hopper Spray



SUPER SCOOP

EIFS Contractors Most Requested Scoop

- Unique Design Scoops the Bucket Clean
- One Scoop Full Fills Your Hawk Perfectly
- Break Resistant Aluminum Construction
- Long Handle Saves Your Back

Item #	Description
BS10	Super Scoop



BUCKET DREDGER

Plastic Dredger Scoop

- One Scoop Fills Your Hawk
- Easy to Clean
- Larger Hook
- Comfort-Handle

Item #	Description
BDRE	Bucket Dredger



UP TO 60 DAY TAPE!



LMR2



STP2

Red Stucco Tape Leaves No Residue and Will Not Fray if Removed Within 60 Days!

RED STUCCO TAPE

Up to 60-Day Red Tape

- UV Protectors Ensure Long Exposure Life
- Aggressive Adhesive Sticks to Almost All Surfaces
- Leaves No Residue if Removed Within 60 Days
- Will Not Fray if Removed Within 60 Days

Item #	Description
LMR2	2" x 60 yds. (per roll)
KITLMR2	2" x 60 yds. (case of 24)

ECONOMY STUCCO TAPE

Affordable Performance

- Durable and Moisture Resistant PE Backed Tape
- Synthetic Rubber-Based Pressure Sensitive Adhesive
- Bonds Well to a Variety of Surfaces
- High Degree of Conformability Without Excessive Stretch

Item #	Description
STP2	2" x 60 yds. (per roll)
KITSTP2	2" x 60 yds. (case of 24)



BT36

BT24

BT12

BLUE WINDOW FILM

Self 90-Day Blue Protective Film

- Protects Glass and Metal Window Frames
- Leaves No Residue
- Removes Easily

Item #	Description
BT12	Blue Tac Tape, 12" x 600'
BT24	Blue Tac Tape, 24" x 600'
BT36	Blue Tac Tape, 36" x 600'

Other Sizes Available Upon Request

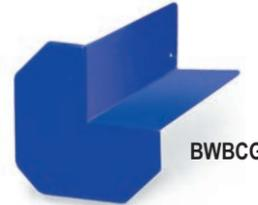

BWBCG

CORNER GUARD

From Waterblock™

- For Corners in Window Frames and Structural Openings

Item #	Description
BWBCG	Corner Guard Flashing, each

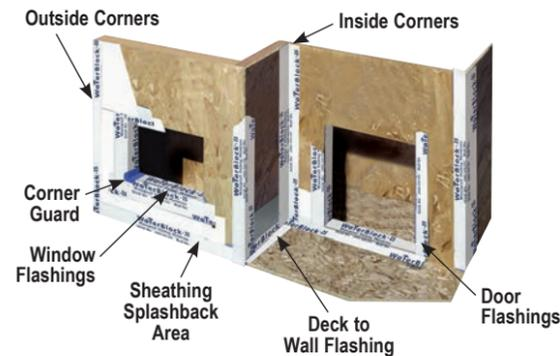

Since 1969 **PLASTIC PC COMPONENTS** inc.

STUCCO

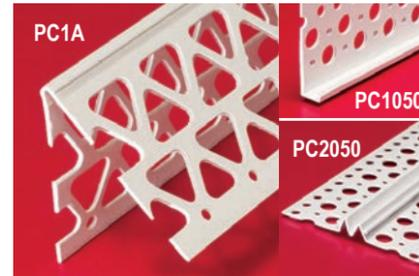

- Rustfree Installation
- Superior Field Performance

Corner Bead

Item #	Description	Quantity
PC1A	2 1/2" X 2 1/2"	50 Per Box

Casing Bead Series

Item #	Description	Quantity
PC1050	1/2" Ground	75 Per Box

V Control Joint Series

Item #	Description	Quantity
PC2050	1/2" Ground	35 Per Box

CI/EIFS

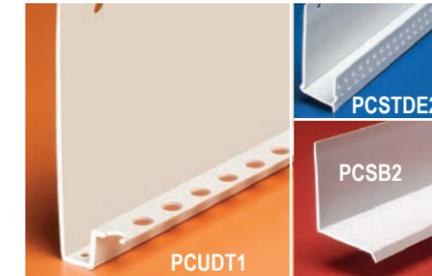

- Improve Job Quality
- Manage Moisture

Universal Drip Trac®

3 1/2" Solid Flange w/ Drip Edge

Item #	Description	Quantity
PCUDT1	Weeped, 1/2" Shelf	40 Per Box

Starter Trac® Drip Edge Series

Item #	Description	Quantity
PCSTDE2	2" (Plus Others)	15 Per Box

Window/door Drip Edge Series

Item #	Description	Quantity
PCSB2	2" (Plus Others)	50 Per Box

Call for Additional Selections

STONE VENEER



- Eliminate Painting
- 4 Molded-in, Permanent Colors

Termination Bead Series

Item #	Description	Quantity
PC1050	1 3/4" Perforated Flange 1/2" (Plus Others)	75 Per Box

Foundation Weep Screed Series

Item #	Description	Quantity
PC63250	1/2" (Plus Others)	35 Per Box

Ultra Drain Mat™ Vent System

Item #	Description	Quantity
PCUDM	.25 or .40" Thick	18 Rolls/Pallet



PROFILES - HUNDREDS OF SELECTIONS AVAILABLE

ARCHMAKER™

Casing Bead

- Easily Conforms to Most Arches and Curves
- 1 3/4" Perforated Flange
- 1/4" to 1" Ground

Item #	Description
VC66	ArchMaker™

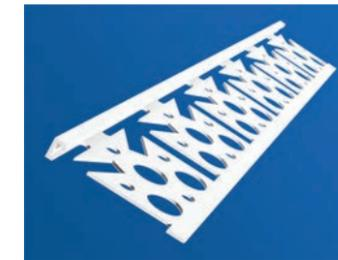

SOFFIT VENT

for Soffit Board

- One-piece Design
- Can Be Combined with Starter Strip / Casing Bead
- 3/8" Ground
- 1" to 6" Wide Vent

Item #	Description
VCV	Soffit Vent

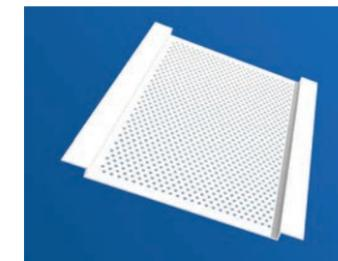

EIFS STARTER STRIP

with Drip Edge

- No Weep Holes
- No Drip Leg
- 5/8" Perforated Face Flange
- 1 3/4" Back Flange

Item #	Description
VCCBS	Starter Strip

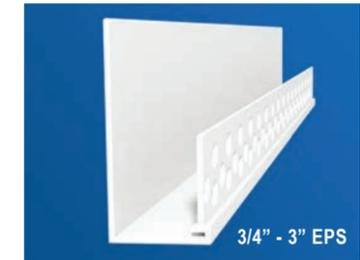

CONTROL JOINT

for Stucco & Plaster

- Relieves Stress and Controls Cracking in Large Areas
- 4" Perforated Face Flange
- 3/8" to 1" Ground

Item #	Description
VC1538	Control Joint



Call for Additional Selections

800.325.7540

UNIVERSAL KICKOUT FLASHING

Eliminates Field-Fabrication Errors

- Saves Time & Money
- Eliminates Field Fabrication Errors
- Cures Galvanic Concerns
- Flexible for Retrofits
- Installs in Just Seconds
- Handles all Temperature Extremes
- Custom Molded Fabrication
- Cuts Easily with Scissors
- Contractor's Choice Since 1998
- 6"x6"x12"



Vortex Relief



Flexible for Retrofits



Cuts Easily with Scissors



Item #	Description	Item #	Description
UKOL	Gray Universal Kickout Left	UKOLB	Brown Universal Kickout Left
UKOR	Gray Universal Kickout Right	UKORB	Brown Universal Kickout Right
UKOLW	White Universal Kickout Left	UKOLT	Tan Universal Kickout Left
UKORW	White Universal Kickout Right	UKORT	Tan Universal Kickout Right

BACKER ROD

Joint Sealer

- Designed for Sealing EIFS Joints
- Resistance to Moisture and Freeze-Cycle Problems
- Conforms to Irregular Joints
- Non-absorbing Closed Cell Skin
- Dispenses Easily from Box to Joint



SR78

SR58

SR38

Item #	Description
SR14	Backer Rod Handy Pack, 1/4" x 2,500'
SR38	Backer Rod Handy Pack, 3/8" x 1,400'
SR12	Backer Rod Handy Pack, 1/2" x 800'
SR58	Backer Rod Handy Pack, 5/8" x 550'
SR78	Backer Rod Handy Pack, 7/8" x 330'
SR1	Backer Rod Handy Pack, 1" x 550'

* Other Sizes Also Available - Please Call

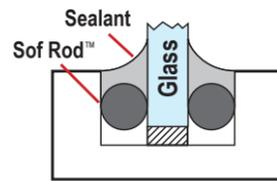

Sof Rod™ for Glazing

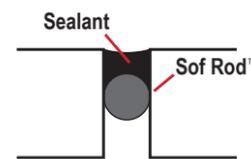

Sof Rod™ in expansion joints and similar applications

TRIANGULAR BACKER ROD

Joint Sealer

- Designed for Sealing EIFS Joints
- Conforms to Irregular Joints
- Non-absorbing Closed Cell Skin
- Adhesive Surface Holds Material in Place
- Resistance to Moisture and Freeze-Cycle Problems



TBR14

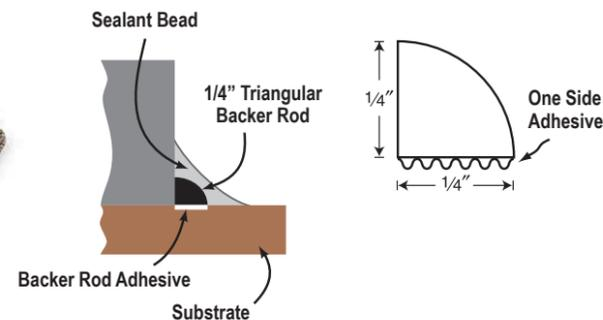

Item #	Description
TBR14	1,800 Feet Roll

* A WORD ABOUT CHEMICALS

Chemicals react differently on various materials. We suggest you follow the instructions carefully. We also recommend that you select a small inconspicuous area to test the chemicals and confirm the results for satisfaction before applying them to the job. Chemicals cannot be returned.

Chemicals are Prohibited on all International and Domestic Air Shipments.

Warning: This product can expose you to chemicals including ethylbenzene, which is known to the State of California to cause cancer and Toluene which is known in the state of California to cause Birth Defects or other reproductive harm. For information go to www.p65Warnings.ca.gov



Tilt-Up Walls



Shapes



FOAM-LOK™ ADHESIVE

EPS Anchor-In-a-Can

- Adheres EPS to EPS
- Fast Setup Time — 5 Minutes*
- Spray Cans Material is Clear Colored
- Does Not Degrade the EPS
- Excellent for — Construction, Signs, Theater, Arts & Crafts, Packaging, Florists & 100's more

Item #	Description
FLAS	Foam Lok™ Adhesive Spray
KITFLAS	Foam Lok™ Adhesive, per case of 12



Theater



Signs

BRUSHABLE Foam-Lok™ Adhesive

Just Pour Into a Container and Brush On. Same Properties as Foam-Lok™ Spray.

Item #	Description
FLA6B	Foam Lok™ Adhesive 5 Gal. Brushable



* Foam-Lok™ will perform as intended – your results could differ if you do not follow the directions. Also atmospheric conditions, temperature, and thickness of application may vary the results. We suggest a trial test with each application to determine acceptable results.



PRO-LOK™
Foam to Foam Adhesive

- High Bonding Strength
- Low Expansion
- Bonds to Most Building Materials
- Seals Gaps to 3"
- High Insulating Value
- Easy To Use

Item #	Description
PLOK	PRO-LOK™ Adhesive, 25.57 oz
KITPLOK	Case of 12 with FGUN2*



PRO-KLEAN™
Adhesive Gun Cleaner

- Cleans Applicator Gun
- Removes Uncured PU Foam
- Pleasant Fragrance
- Acetone Based Cleaner
- 2 Year Shelf Life

Item #	Description
PKLEAN	PRO-KLEAN™ Cleaner, 13.4 oz
KITPKLEAN	Case of 12



FREE!
FGUN2
with Purchase of a
Case of PRO-LOK™



FREE!
FGUN2
with Purchase of a Case of
ENERFOAM™ 42 or 25

ENERFOAM™ 42
Filler and Adhesive-In-One

- Foam Adhesive and Filler
- Bonds Quickly to Almost Anything
- One Can is Equal to 40 Quart Tubes of Adhesive
- Cures Initially in 10 Minutes
- Polyurethane Based
- 950 Lineal Feet at 1/2" Bead

Item #	Description
ENER42	30 oz. EnerFoam Can
KITENER42	30 oz. EnerFoam Cans (cs of 12) wGun
ENER25	24 oz. EnerFoam Can



ENERFOAM™ 25
Filler & Adhesive-In-One

- Same as Enerfoam™42 Except Smaller Container
- Cures Initially in 10 Minutes
- Polyurethane Based
- 712 Lineal Feet at 1/2" Bead
- Controlled Dispensing

Item #	Description
KITENER25	24 oz EnerFoam Cans (cs of 12) wGun*
ENER24	24 oz. Straw EnerFoam Can
KITENER24	24 oz. Cans (cs of 12)



ENERFOAM™ 24
Filler & Adhesive-In-One

- No Gun Required
- Straw Dispenser
- Same as Enerfoam™42 Except Smaller Container
- Cures Initially in 10 Minutes
- Polyurethane Based
- 712 Lineal Feet at 1/2" Bead

Chemicals are Prohibited on all International and Domestic Air Shipments.



ECONOMY GUN

Item #	Description
FGUN2	Economy Gun



MID-RANGE GUN

Item #	Description
ENER14	Mid-Range Gun

PRO-LOK™ KITS



PRO-LOK™ STARTER KIT

- 2 Cans of 25.57 oz. PRO-LOK
- 1 Pro Dispensing Gun FGUN2
- 1 Can of PRO-KLEAN Cleaner

Item #	Description
PLOKSK	PL Starter Kit



PRO-LOK™ JUNIOR KIT

- 6 Cans of 25.57 oz. PRO-LOK
- 1 Pro Dispensing Gun FGUN2
- 1 Can of PRO-KLEAN Cleaner

Item #	Description
PLOKJK	PL Junior Kit



PRO-LOK™ MASTER KIT

- 12 Cans of 25.57 oz. PRO-LOK
- 1 Pro Dispensing Gun FGUN2
- 2 Can of PRO-KLEAN Cleaner

Item #	Description
PLOKMK	PL Master Kit

ENERFOAM™ KITS



ENERFOAM™ 42 STARTER KIT

- 2 Cans of 30 oz. Enerfoam 42
- 1 Pro Dispensing Gun FGUN2
- 1 Can of Enerfoam Cleaner

Item #	Description
ENER42SK	42 Starter Kit



ENERFOAM™ 42 JUNIOR KIT

- 6 Cans of 30 oz. Enerfoam 42
- 1 Pro Dispensing Gun FGUN2
- 1 Can of Enerfoam Cleaner

Item #	Description
ENER42JK	42 Junior Kit



ENERFOAM™ 42 MASTER KIT

- 12 Cans of 30 oz. Enerfoam 42
- 1 Pro Dispensing Gun FGUN2
- 2 Cans of Enerfoam Cleaner

Item #	Description
ENER42MK	42 Master Kit



ENERFOAM™ CLEANER

Item #	Description
ENER10	12 oz EnerFoam Cleaner
KITENER10	12 oz Cleaner (case of 12)



OFF-BASE™
Powerful EIFS Cleaner

- Removes Hardened Synthetic Stucco
- Cleans and Removes Stucco From Tools
- Removes Stucco From Concrete, Brick, Glass & Wood
- Not for Use on Painted or Anodized Finishes

Item #	Description
OBS	Off-Base™ Spray, 18 oz.
KITOBBS	Off-Base™ Spray, per case of 12
OB1	Off-Base™, 1 gallon



FINISH-UP™
Gentle EIFS Cleaner

- Cleans and Removes Stucco From Tools
- Removes Stucco From Concrete, Brick, Glass & Wood
- Does Not Damage Painted or Anodized Finishes

Item #	Description
FUS	Finish-Up™ Spray, 16 oz.
KITFUS	Finish-Up™ Spray, per case of 12
FU1	Finish-Up™, 1 gallon



SOFT POLYURETHANE SAW

Pneumatic Hand Held Saw

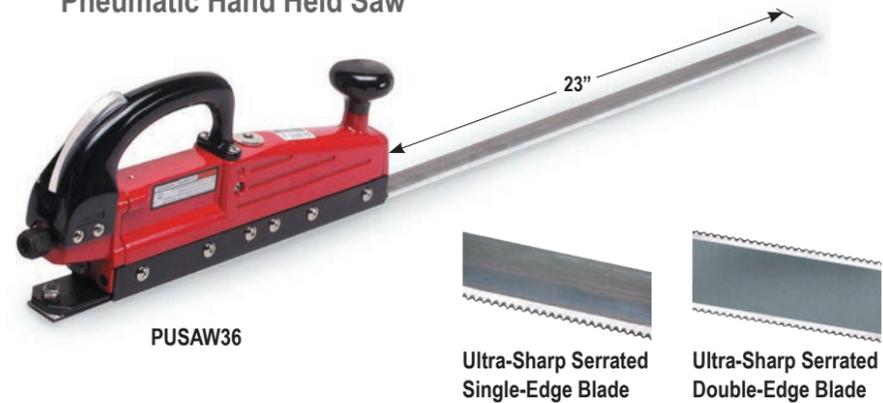

PUSAW36

Ultra-Sharp Serrated Single-Edge Blade

Ultra-Sharp Serrated Double-Edge Blade

- Designed for Soft Urethane 1/2 Pound Insulation
- Ultra Sharp Blade Cuts Quickly
- Free Speed of 3,000 RPMs
- Requires 8 CFM @ 93 PSI
- Weighs Just 7 Pounds
- Blade Length Past Tool - 23"
- Powered by IngersollRand® Straight Line Sander
- 1 1/4" Blade Travel

Item #	Description
PUSAW36	Polyurethane Saw - Includes Blade
PUBLADE36	Replacement Blade
PUBLADE36DE	Double-Edge Replacement Blade

Air Hose and Connections Not Included

SOFT SPRAY-FOAM SAW

Electric Hand Held Saw

- Designed for Soft Urethane 1/2 Pound Insulation!
- Ultra Sharp Blade Cuts Quickly
- Free Speed of 3,000 RPMs
- Weighs Just 10 Pounds
- Blade Length Past Tool - 29"
- 1 1/4" Blade Travel



PUSAWE

Item #	Description
PUSAWE	Polyurethane Saw - Includes Blade
PUBLADE29	Replacement Blade

ASPHALT & TAR REMOVER

Heavy Duty Cleaner for Masonry and Concrete

- Removes Asphalt, Tar (roofer's stain), Grease, Hydraulic Oil, Motor Oil



Item #	Description
TR1	Tar Rid / 1 gal.
TR5	Tar Rid / 5 gal.



WASH DOWN

New Formula

- Cleans Stucco, Stone, Tile, Masonry and Concrete
- Removes Grease and Oil from EIFS and other Hard Surfaces
- Safe for Interior and Exterior Cleaning

Item #	Description
WD1	Wash Down / 1 gal.
WD5	Wash Down / 5 gal.

CONCRETE & STUCCO KILLER™

Acid Alternative Concrete Dissolver

- No Sulfuric, Muriatic, Hydrochloric or Phosphoric Acid
- Cleans and Removes Concrete from Hand Tools, Siding, Wooden Decks, Pumps, Molds, Forms, Mixers and More
- Removes Cured Cement, Concrete, Mortar, Grout & Stucco
- Water Soluble



Item #	Description
CSK5	Concrete & Stucco Killer™, 5 gal.



EFFLORESCENCE REMOVER

Removes Efflorescence From Brick, Stone, Concrete & Block

- Contains Hydrochloric Acid
- Etches Concrete, Removes Efflorescence Bleeding and Dissolves Scale & Corrosion

Item #	Description
ER1	Efflorescence Remover



Compares to Bosch Foam Cutter

AKUFOAM CUTTER

4", 8" & 12" Polyurethane Cutter

- Variable Speed Control
- Dual Cutting Blades
- Detachable Base with Glide Rollers
- Made in the U.S.A.

Item #	Description
AKU4	4" Cutting Height Saw
AKU8	8" Cutting Height Saw
AKU12	12" Cutting Height Saw

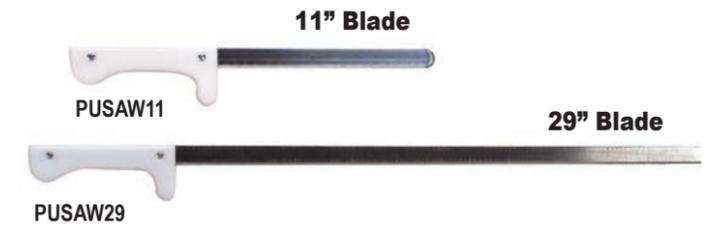

PUSAW11

29" Blade

PUSAW29

POLYURETHANE SAWS

11" & 29" Hand Saws For 1/2 Pound Soft Foam



Ultra-Sharp Serrated Blade like the Pneumatic Saw Above

Item #	Description
PUSAW11	Polyurethane Hand Saw
PUSAW29	Polyurethane Hand Saw

Chemicals are Prohibited on all International and Domestic Air Shipments.



POLY-SPRAY 1™ SYSTEM

Polyurea Spray Hardcoat



PSG

- Environmentally Safe
- Contains no VOC's
- Coating is Paintable
- Color is Neutral
- Dries in 7 Minutes at 70°
- May be Painted After 7 Minutes
- Six 750 ml Cartridges will Cover 127 Sq Ft. at 30 mils
- 100% Solids, Two-component Aromatic Polyurethane
- Smooth Finish



PSMT



PS75

Item #	Description
PS75	Cartridge, Each
KITPS75	Cartridge, Case of 6
PSG	Spray Gun
PSMT	Static Mixer w/ Atomizing Tip

Static Mixer w/ Air Atomizing Tip Comes w/ Each Cartridge

Compressor Requirements: Standard 5 hp compressor, with a 20 gallon tank capable of 10 to 12 CFM. For optimum performance, the supply pressure must be greater than 100 P.S.I. and less than 145 P.S.I. Protective clothing, eye and breathing devices should be worn.

SPECIALTY COATINGS

ELASTA-SHIELD™

Smooth Vinyl-Acrylic Protective Skin

Dries clear. Water soluble flexible shield protects EPS foam for general handling. Will act as an adhesive for applying fabrics if they are applied while Elasta-Shield is wet. Can be brushed, rolled or sprayed. Covers 320 sq. ft. at 5 mils.



DO NOT STORE BELOW 40°F FAHRENHEIT

Item #	Description
ESC	Elasta-Shield™ 1 Gallon
KITESC	Elasta-Shield™ 4 Gallon



Calculating Square Footage of Coatings per Gallon

1 mil thickness of liquid will theoretically cover 1604 sq. ft.
5 mils thickness of liquid will theoretically cover 320 sq. ft.

2-PART HAND-APPLIED HARD SHELL COATINGS

LIQUID ROCK™

2-Part Epoxy

Liquid Rock is a 2-part epoxy based coating that can be applied on interior surfaces. It has extraordinary flow characteristics. It leaves a hard glossy smooth shell finish. It works well on props and backdrops when a hard finish is preferred. It can be brushed or rolled. Average working time is 20-25 minutes. 1 gallon covers approximately 320 sq. feet at 5 mil thickness. Dries off-white and can be painted.



Item #	Description
LR1	Liquid Rock™ 1 Gallon
KITLR1	Liquid Rock™ 4 Gallon Kit

DO NOT EXPOSE TO DIRECT SUNLIGHT
DO NOT STORE BELOW 40°F FAHRENHEIT



URESHELL™

2-Part Urethane

UreShell is a marvelous hard coat 2-part urethane-based coating. 20-25 minute working time allows for rolling or brushing. Applications cover interior surfaces. It leaves a hard glossy smooth shell finish. It works great on props, backdrops, signs, molds, etc. 1 gallon covers approximately 320 sq. feet at 5 mil thickness. Dries to a tan color and can be finish coated with most paints and synthetic stucco.



Item #	Description
US1	UreShell™ 1 Gallon
KITUS1	UreShell™ 4 Gallon Kit

DO NOT EXPOSE TO DIRECT SUNLIGHT
DO NOT STORE BELOW 40°F FAHRENHEIT





HD FOAM RAFT CUTTER™

HEAT-DIAL CRAFT-CUTTER™
Variable Heat Craft-Cutter

Item #	Description
CRAFTHD	HD Craft Cutter

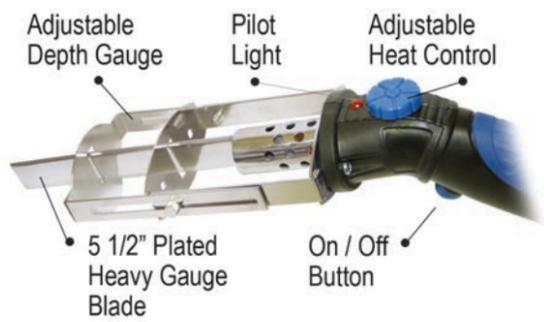

CRAFTERS PRECISION HOT KNIFE

Rod Style Knife

- Continuous Duty Cycle
- 1/8" Diameter Stainless Steel Tube
- Versatile Sled Guide Accessory

Item #	Description
HKT6PR6	6" Knife with Sled
HKT6PR9	9" Knife with Sled
HKT6PR69	6" & 9" Knives with Sled

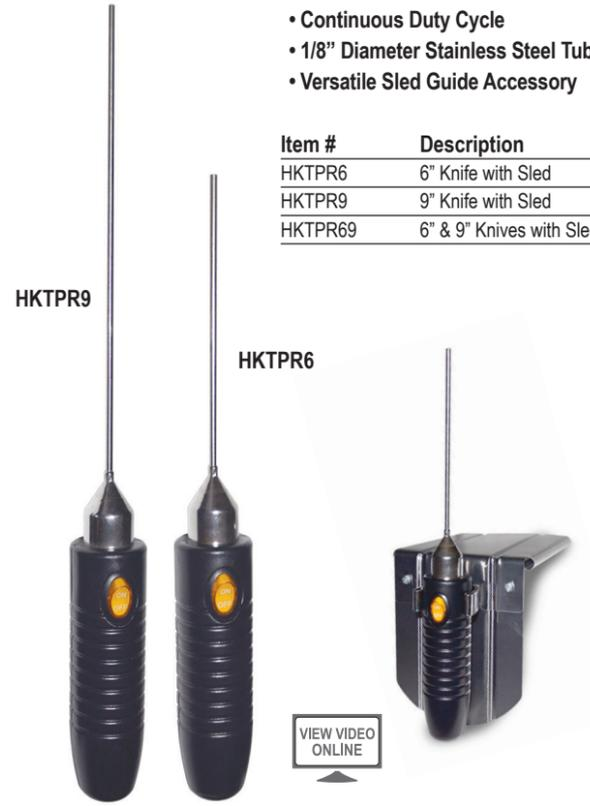

For these products visit our website for product details and search by Item Number



CANVAS BAG



CB24

FABRIC CLOTH CUTTER HOT KNIFE

Fabric Cutter Hot Knife Cuts & Seals Sail Canvas, Cloth and Other Synthetic Fabrics



HKFC

CRAFT TABLE CUTTER

11" x 15" Table

- Cuts angles, cones, cylinders and straight lines
- Grid protractor for cutting 0° to 60° angles
- Wire spool included
- 5 5/8" Wire Height
- Uses NWMANIX wire

Item #	Description
CTC145	Craft Table Cutter

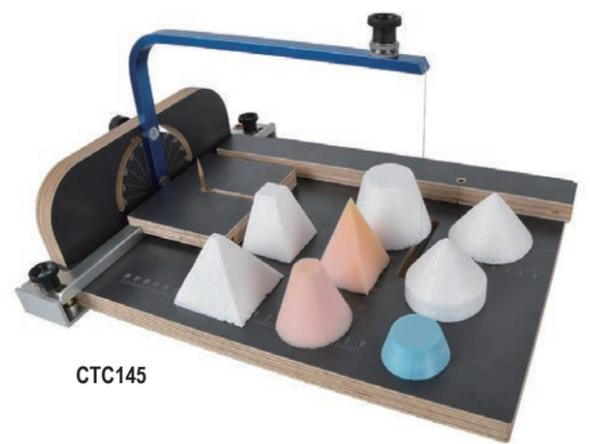

CTC145

ZETZ 20™

Thermocutter



ZTC20

ZETZ 24™

Designed for Industrial Operations



ZETZ24 Comes with 3" Z75 Blade

ZETZ SPECIALTY BLADES



#Z06
0.6 mm Thick
3 mm Cutting Edge



#Z40
0.6 mm Thick
40 mm Cutting Edge



#Z35
1.0 mm Thick
35 mm Cutting Edge



#Z45
.8 mm Thick
45 mm Cutting Edge



#Z70
1.0 mm Thick
70 mm Cutting Edge

MAXX SOLDERING GUN

2 In 1, MAXX 2 1/2" Foam Cutting Blade & Soldering Gun Hot Knife



HKTMX

HKTMX250

2 In 1 Soldering Gun, & Fabric Cutter



HKTMXFC

3 In 1 Soldering Gun, & Fabric Cutter



HKTMXF3

For these products visit our website for product details and search by **Item Number**

FOAM SHAVING CURRY COMB

Foam Shaper/Scraper



CC15S

AIR EXPRESS™

Uses Adhesive Rasp Paper



KITAE818

EASY COAT COATING

Specifically Designed For Shape Coating 50-60sq. ft. @ 1/4"



EC50G
EC50W
Available in Gray or White

Pallet Quantities Only
Minimum Order 112 bags

DELMHORST™ MOISTURE METER

Digital Probe Tester

BD2100



ROPE CUTTER II

Cuts and Fuses Nylon, Dacron, Polypropylene Line & Rope

RCUT2



HDC 220 POWER CONVERTER



HDC220

STUB NAILS & HAMMER

Stucco Stub Nails & Magnetic Hammer

MAGHAMP02



MAGHAM

CONTROL FIBERS

Prevents Stucco Cracks



CF36

BACKER ROD INSTALLER KIT

Installs Backer Rod Quickly



Both Tools Included in Kit

Uneven Surface Tool

Level Surface Tool

QRT100

DOW® FROTH-PAK® 12

Two Component Foam 12 Board Feet, 1 Cubic Foot

DFRPK



**DOW® FROTH-PAK®
620 & 650A**

Two Component Foam

620 = 620 Board Feet, 51.667 Cubic Feet
650A = 650 Board Feet, 54.167 Cubic Feet



DFP620

**DOW® FROTH-PAK®
200 & 210A**

Two Component Foam

200 = 200 Board Feet, 16.7 Cubic Feet
210A = 210 Board Feet, 17.5 Cubic Feet



DFP200



1/2 THRU 10+LB FOAM FOR OPEN CELL OR CLOSED CELL FOAM

HARD WIRE
Poly-Plane 2



PUP216A (16")
PUP224A (24")

CARBIDE BLADE
Poly-Plane 2



PUP216AC (16")
PUP224AC (24")

**WOOL INSULATION
CUTTER**



WIC16

**CORDLESS WOOL
INSULATION CUTTER**

Battery Powered Cutter



WIC12B

Lithium-ion
Battery

RACER™ AND TITAN™ TROWELS



TUCK POINTERS

Wood or Soft Grip Handle (page 35)



EDGER KITS

Convenient Kits for Display
Talk to Us For More Details

- KITICE Inside Corner Edgers Kit (All 5)
- KITOCE Outside Corner Edgers Kit (All 5)
- KITTS All 3 Sizes in Kit (1 Each)

BALTIC SCOOP

Scoop Trowel Tool (page 41)



TOOL HANGERS

Fits Edgers and Trowels

- Organizes Tool Display
- Fits Single or Double Peg Hangers
- Nylon Construction

New, Stronger Washer Boxes

PBH and Assembled Boxes

- New Handle Design
- Reinforced Cardboard
- New Box Graphics - Clear information and helpful tips



**NEW
HANDLE DESIGN**

YOUR ORDER IS ON THE WAY

98%
OF ORDERS
SHIP SAME DAY



**ASK US ABOUT A FREE
DISPLAY STAND FOR
YOUR STORE**

DISPLAY STANDS

NOTES:

demandproducts.com | 800-325-7540

DEMAND ORIGINALSTM

RacerTM Trowels



TitanTM Trowels



PBHTM Washer



Bow CutterTM



Pro-LokTM



Groove JetTM



DuraRaspTM



Carve360TM

